



GOODWE
YOUR SOLAR ENGINE



SMT Series Quick Installation Guide

Ver.1.0
2021-06-30

General Disclaimer

- The information in this quick installation guide is subject to change due to product updates or other reasons. This guide cannot replace the product labels or the safety precautions in the user manual unless otherwise specified. All descriptions here are for guidance only.
- Before installations, read through the quick installation guide and the user manual to learn about the product and the precautions.
- All installations should be performed by trained and knowledgeable technicians who are familiar with local standards and safety regulations.
- Check the deliverables for correct model, complete contents, and intact appearance. Contact after sales service if any damage is found or any component is missing.
- Use insulating tools and wear personal protective equipment when operating the equipment to ensure personal safety. Wear anti-static gloves, cloths, and wrist strip when touching electron devices to protect the inverter from damage.
- Strictly follow the installation, operation, and configuration instructions in this guide and user manual. The manufacturer shall not be liable for equipment damage or personal injury if you do not follow the instructions. For more warranty details, please visit <http://www.goodwe.com>.

Safety Disclaimer



Warning

DC Side:





1. Ensure the component frames and the bracket system are securely grounded.
2. Connect the DC cables using the delivered DC connectors and terminals. The manufacturer shall not be liable for the equipment damage if other connectors or terminals are used.
3. Ensure the DC cables are connected tightly and securely.
4. Measure the DC cable using the multimeter to avoid reverse polarity connection. Also, the voltage should be under the permissible range ($\leq 1100V$).

AC Side

1. The voltage and frequency at the connecting point should meet the on-grid requirements.
2. An additional protective device like the circuit breaker or fuse is recommended on the AC side. Specification of the protective device should be at least 1.25 times the AC output rated current.
3. PE cable of the inverter must be connected firmly. The resistance between the neutral wire and the earth cable is less than 10Ω .
4. You are recommended to use copper cables as AC output cables. Contact the manufacturer if you want to use aluminum cables.

Inverter Side:

1. Terminals at the bottom of the inverter cannot bear much load. Otherwise, the terminals will be damaged.
2. All labels and warning marks must be clear after the installation. Do not scrawl, damage or block any label on the device.
3. Warning labels on the inverter are as following.

	High voltage hazard. Power off the inverter first before any operations.		Potential risks exist. Wear proper PPE before any operations.
	Read through the guide before any operations.		Delayed discharge. Wait until the components are totally discharged after power off.
	High temperature hazard. Do not touch the equipment to avoid being hurt.	N/A	N/A

Check Items Before Switching Power ON

No.	Check Item
1	The inverter is firmly installed at a clean place where is well-ventilated and easy-to-operate.
2	The PE cable, DC input cable, AC output cable, and communication cable are connected correctly and securely.
3	Cable ties are routed properly and evenly, and no burrs.
4	Unused ports and terminals are sealed.
5	The voltage and frequency at the connection point meet the on-grid requirements.

02 Product Introduction

Parts

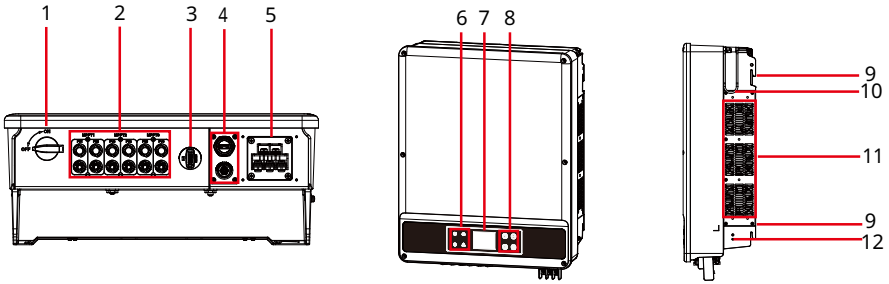

- | | | |
|--------------------------------|----------------------|---------------------------------|
| 1. DC Switch | 2. PV Input Terminal | 3. WiFi/4G/LAN/GPRS Module Port |
| 4. Communication Cable Port[1] | 5. AC Terminal | 6. Indicator |
| 7. LCD[2] | 8. Button | 9. Mounting Plate |
| 10. Handle[3] | 11. Fan | 12. PE Terminal |

1. DRED or RSD or RS485 or USB, depending on different inverters.
2. Some models are designed without LCD.
3. The handle is optional.

Dimensions

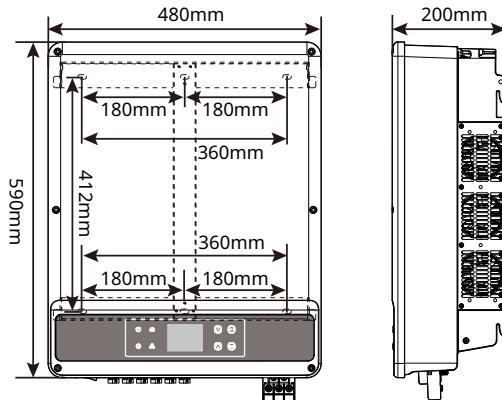

03 Inverter Installation

Packing List

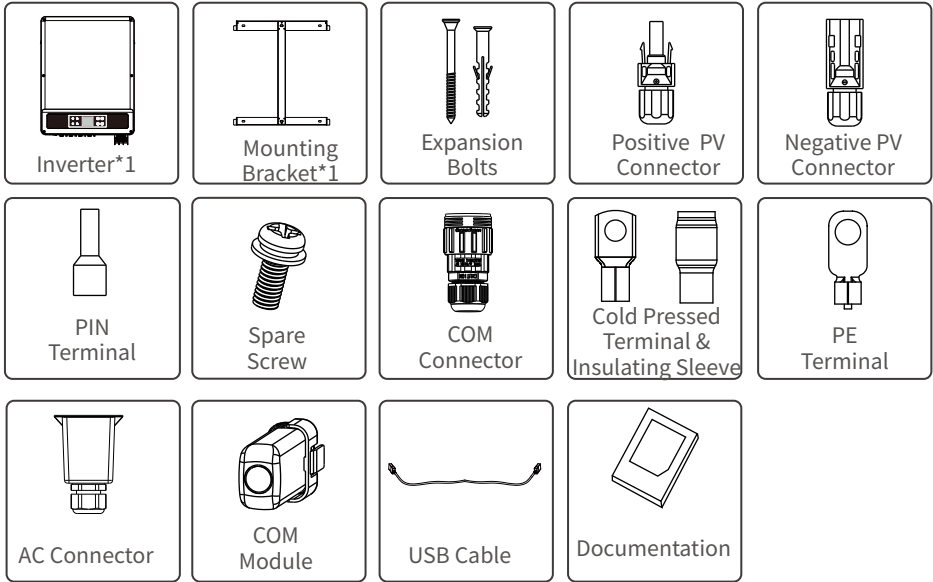

- Number of expansion bolts, PIN terminals, screws, COM connector, PV connectors are various depending on different inverters. The actual accessories may be different.
- Communication module types: WiFi/4G/LAN/GPRS etc. The actual module delivered depends on the communication method of the selected inverter.
- The COM connector is used to connect RS485, and remote shutdown communication cables.
- USB cable is optional.

Space Requirements

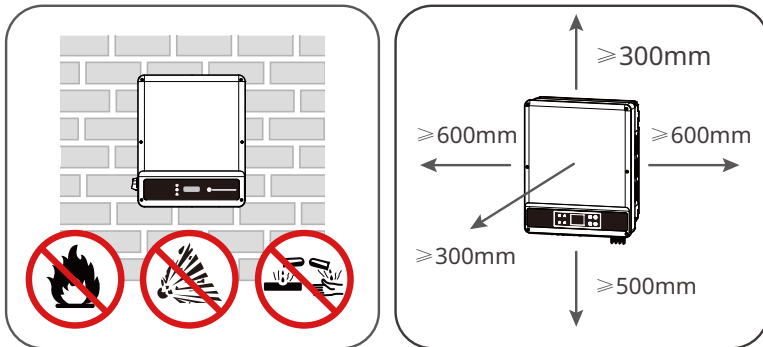

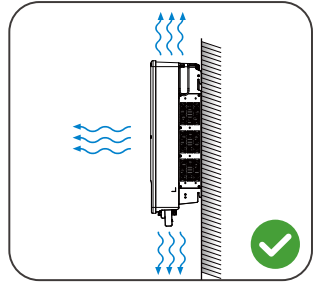
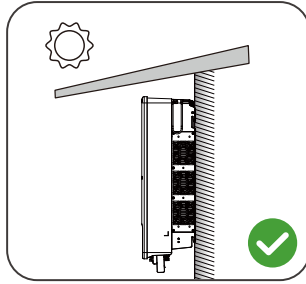
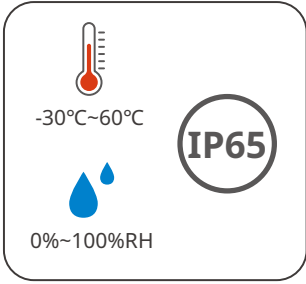

Angle Requirements

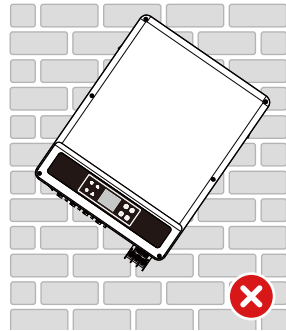
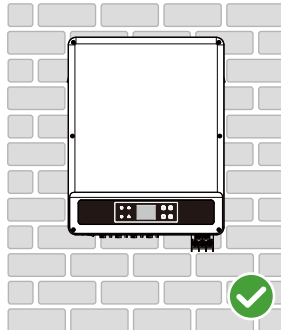
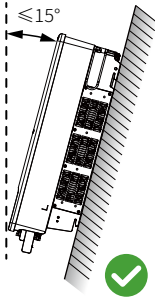

Installing the Inverter

Avoid the water pipes and cables buried in the wall when drilling holes.

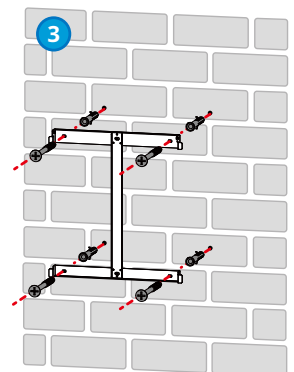
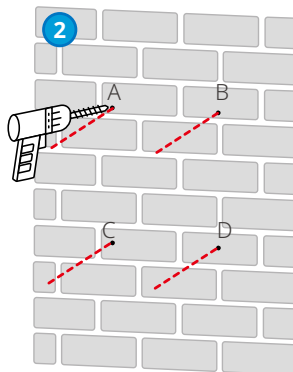
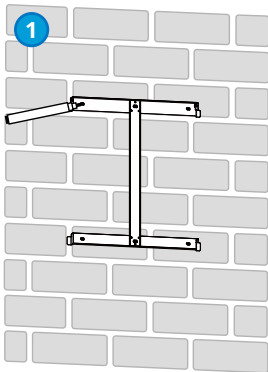

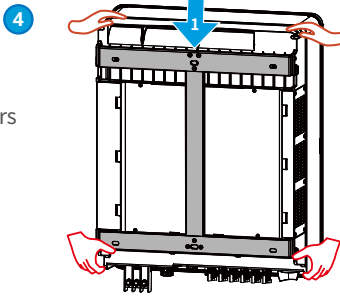

Installing inverters without handles

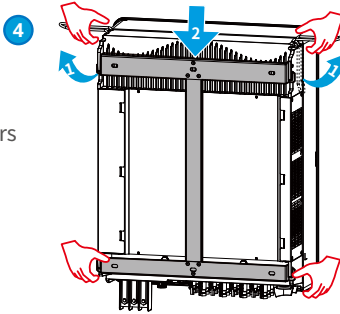

Installing inverters with handles

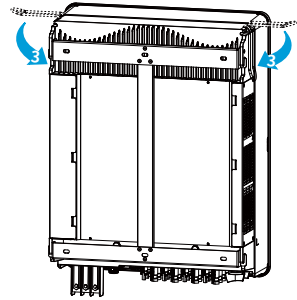

04 Electrical Connection

Connecting the PE Cable

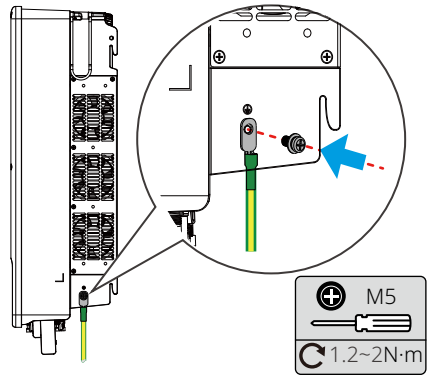
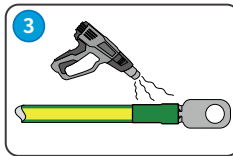
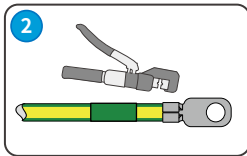
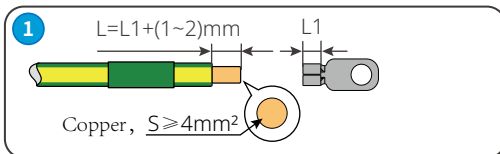

Connecting the AC Cable

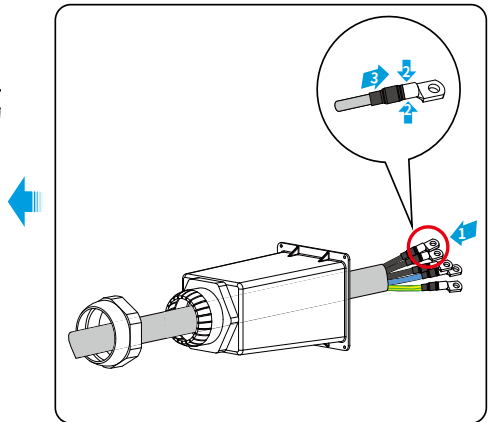
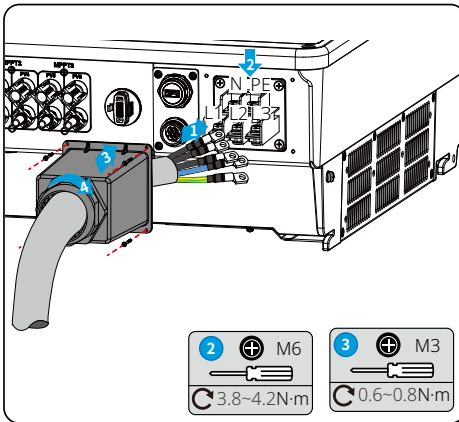
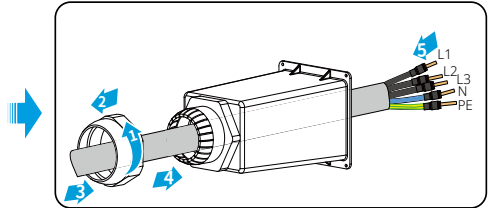
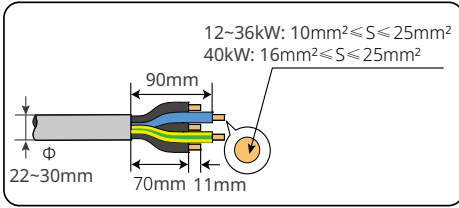
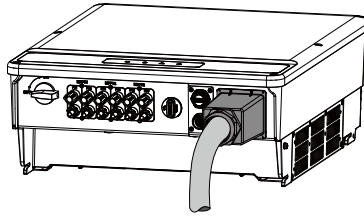

Connecting the DC Cable

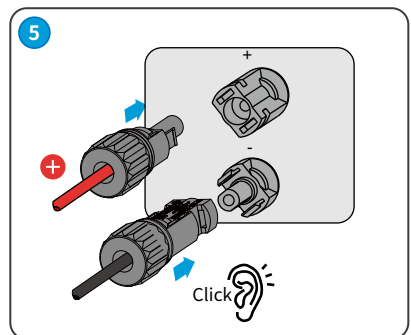
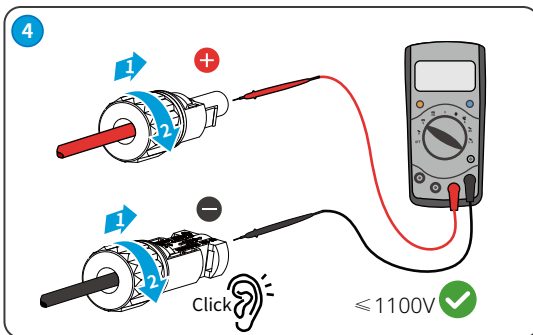
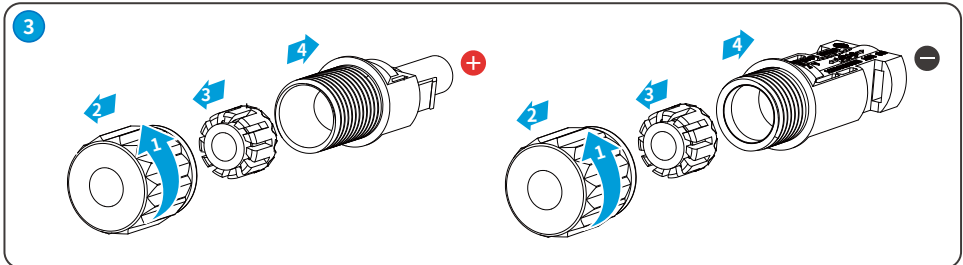
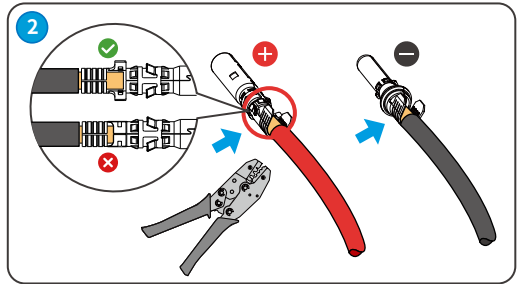
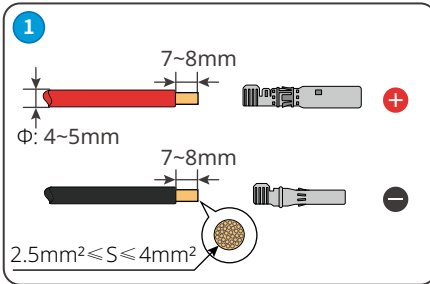
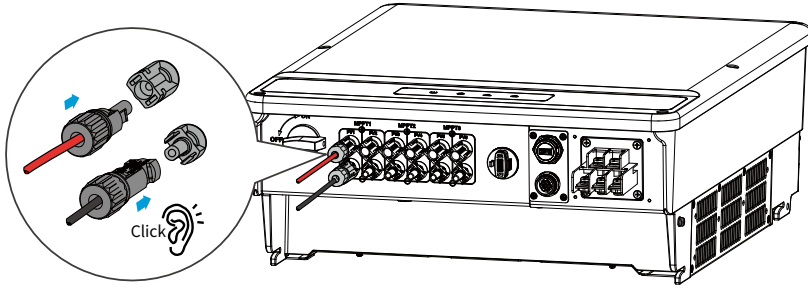

Connecting DRED or RS485 6pin Communication Cable (optional)

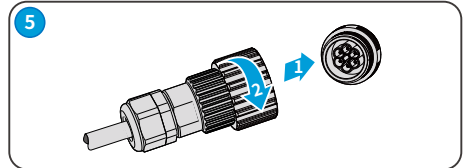
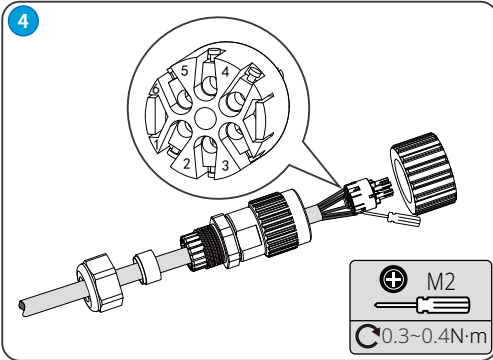
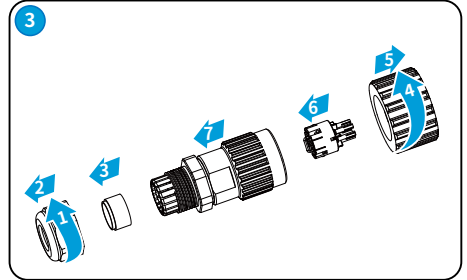
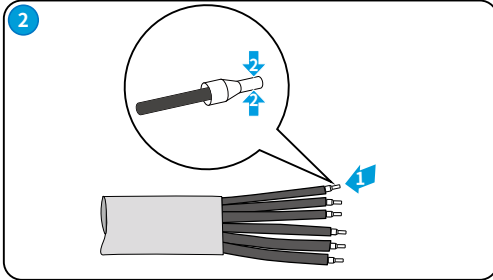
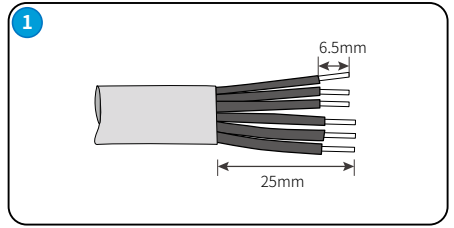
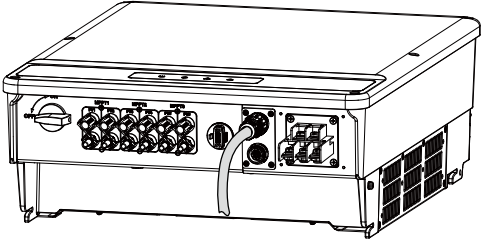

NO.	DRED	NO.	RS485
1	DRED1	1	RS485-A1
2	DRED2	2	RS485-B1
3	DRED3	3	RS485-A1
4	DRED4	4	RS485-B1
5	REF1	5	RS485-A2
6	REF2	6	RS485-B2

Connecting Remote Shutdown 2pin Communication Cable (optional)

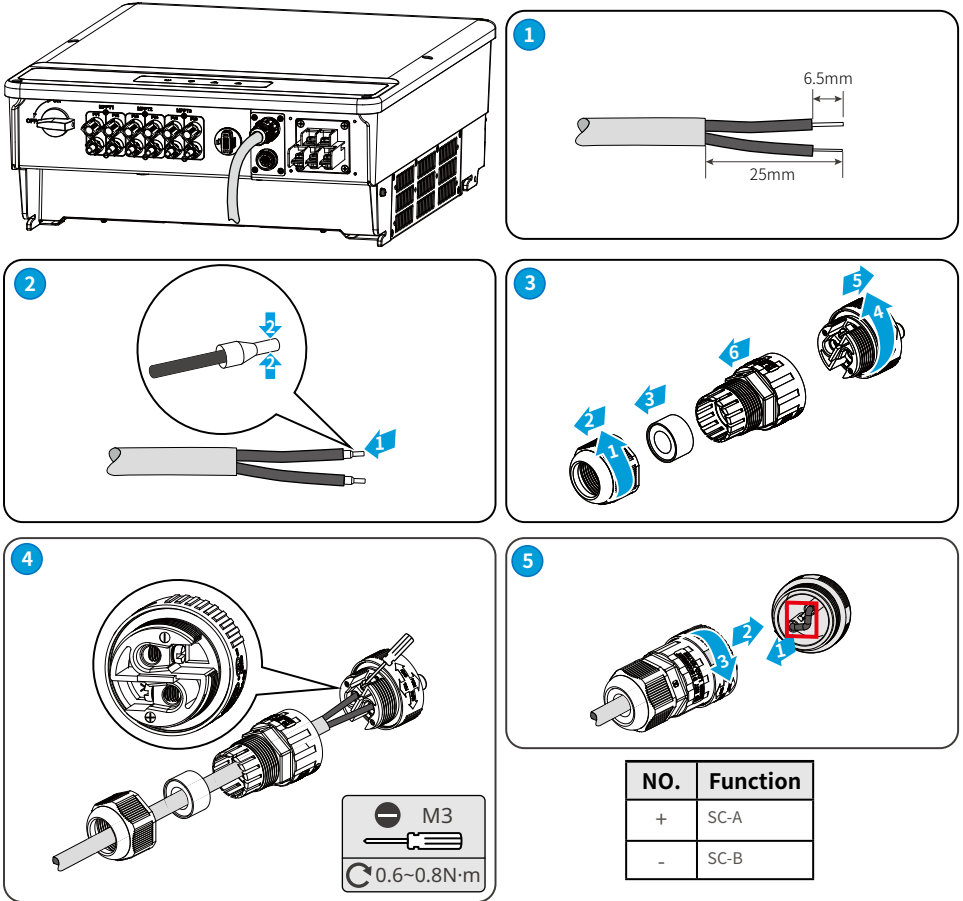

Connecting USB Cable (optional)

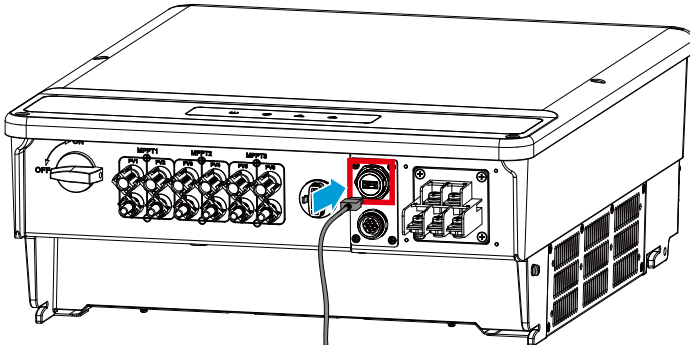

Connecting RS485 5pin Communication Cable (optional)

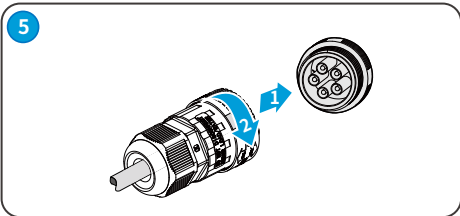
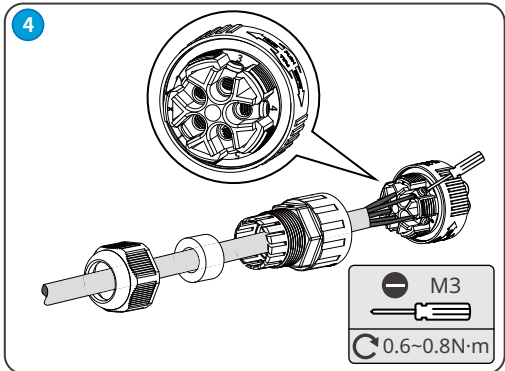
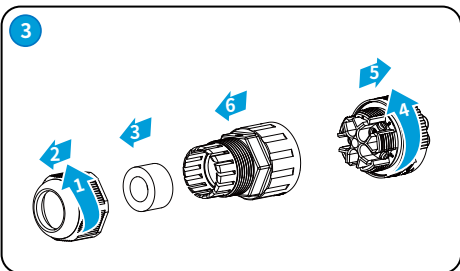
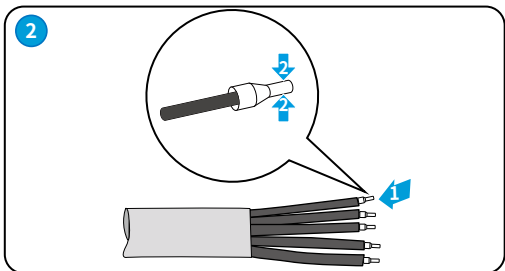
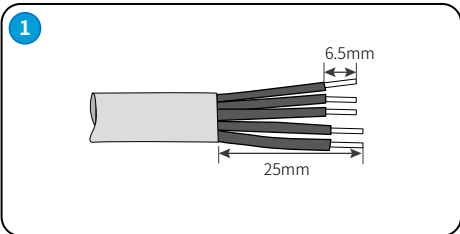
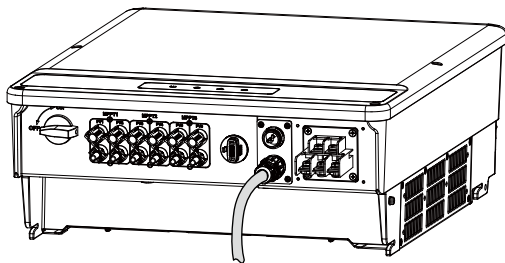

NO.	Function
1	RS485-A1
2	RS485-B1
3	RS485-A1
4	RS485-B1
5	Gen

Installing Communication Module

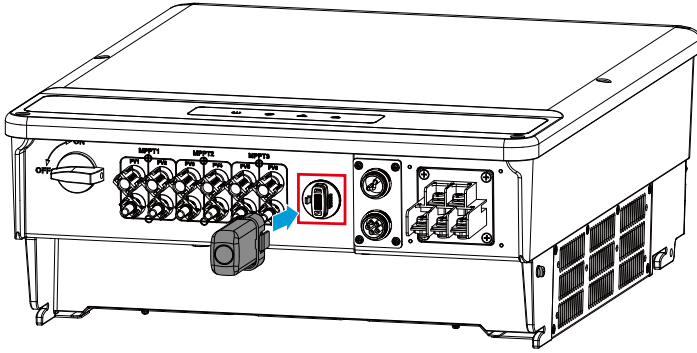









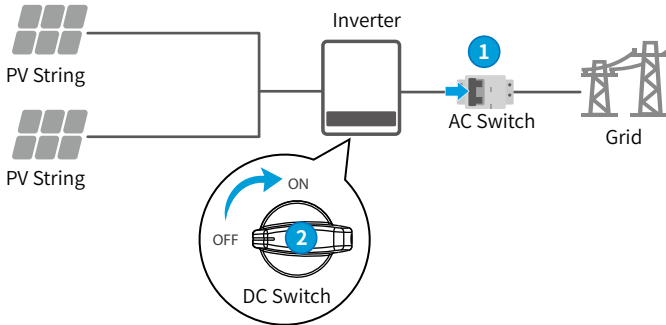





05 Power On

1. If it displays **Select Country/Region** on the LCD when you power on the equipment for the first time, you can set the safety country via the LCD or SolarGo APP. For more details, refer to Commissioning part. For other settings, please refer to the user manual.
2. Observe the indicators to check the inverter status. If any fault exists, please refer to the Troubleshooting part in the user manual.



User Manual



Indicator	Status	Description	
(!) Power		Steady Green	Power On
		Off	Power Off
▶ Operating		Steady Green	The power grid is working properly. The inverter is on grid.
		Off	Off grid
		Single Green Blinking Slowly	Self-check before grid tying.
		Single Green Blinking Quickly	The inverter is to be grid-tied.
☁ SEMS		Steady Green	The wireless monitoring is normal.
		Single Green Blinking Quickly	WiFi module reset or restore.
		Double Green Blinking	Not connected to the router
		Quartic Green Blinking	Not connected to the monitoring website
		Single Green Blinking Slowly	RS485 working normally
		Off	The WiFi module is restoring.
⚠ Faulty		Steady Red	System Fault.
		Off	No Fault.

06 Commissioning

Commissioning via LCD

Select the right safety country via LCD if the inverter is equipped with an LCD.

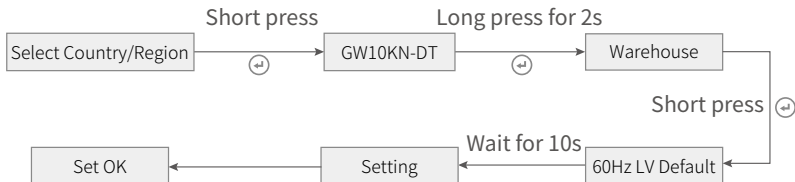

Commissioning via SolarGo APP

Note

1. Search for “Solar Go APP” in Google Play or App Store.
2. Operation steps are the same for Android system and iOS system, although the two interfaces are slightly different. The introduction here is based on Android system.
3. Log in using the initial password for the first time and change the password as soon as possible. To ensure account security, you are advised to change the password periodically and keep the new password in mind.

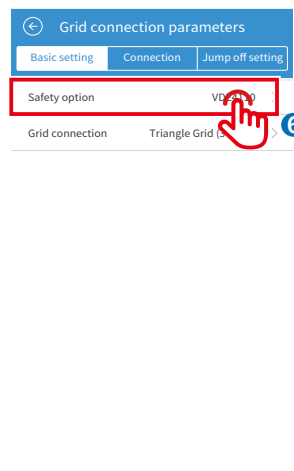
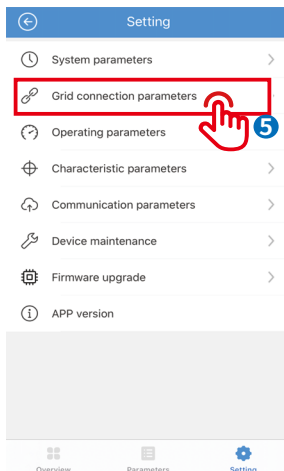
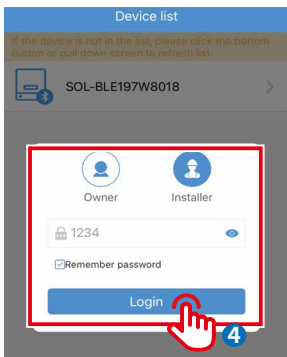
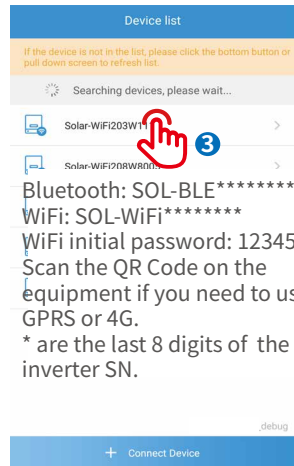
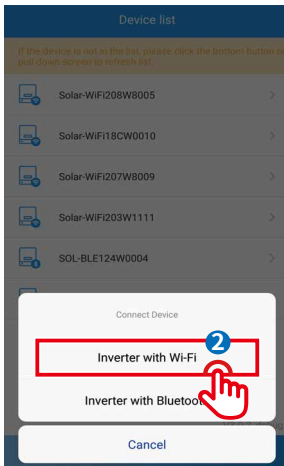
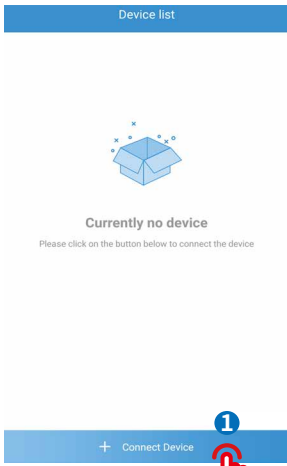

- Initial password for Bluetooth/WiFi: 1234
- Initial Password for GPRS or 4G: the last 4 digits of the inverter bar code.



SEMS Portal App



GOODWE Official
Website



SolarGo App



340-00559-01

JIANGSU GOODWE POWER SUPPLY TECHNOLOGY CO.,LTD

No. 90 Zijin Rd., New District, Suzhou, 215011, China

www.goodwe.com

service@goodwe.com