

# Quick Start Guide

## Fronius Smart Meter IP



[manuals.fronius.com/  
html/4204260464](https://manuals.fronius.com/html/4204260464)

**FIND MORE  
INFORMATION**



**DE:** Hiermit erklärt Fronius International GmbH, dass der Funkanlagentyp Fronius Smart Meter IP der Richtlinie 2014/53/EU entspricht. Der vollständige Text der EU-Konformitätserklärung ist unter der folgenden Internetadresse verfügbar: [www.fronius.com](http://www.fronius.com)

**EN:** Fronius International GmbH declares that the radio equipment type Fronius Smart Meter IP is in compliance with Directive 2014/53/EU. The full text of the EU declaration of conformity is available at the following internet address: [www.fronius.com](http://www.fronius.com)

**FR:** Le soussigné, Fronius International GmbH, déclare que l'équipement radioélectrique du type Fronius Smart Meter IP est conforme à la directive 2014/53/UE. Le texte complet de la déclaration UE de conformité est disponible à l'adresse internet suivante: [www.fronius.com](http://www.fronius.com)

**IT:** Il fabbricante, Fronius International GmbH, dichiara che il tipo di apparecchiatura radio Fronius Smart Meter IP è conforme alla direttiva 2014/53/UE. Il testo completo della dichiarazione di conformità UE è disponibile al seguente indirizzo Internet: [www.fronius.com](http://www.fronius.com)

**PB:** O(a) abaixo assinado(a) Fronius International GmbH declara que o presente tipo de equipamento de rádio Fronius Smart Meter IP está em conformidade com a Diretiva 2014/53/UE. O texto integral da declaração de conformidade está disponível no seguinte endereço de Internet: [www.fronius.com](http://www.fronius.com) Este equipamento não tem direito à proteção contra interferência prejudicial e não pode causar interferência em sistemas devidamente autorizados. ANATEL: 19624-23-16174

**ES:** Por la presente, Fronius International GmbH declara que el tipo de equipo radioeléctrico Fronius Smart Meter IP es conforme con la Directiva 2014/53/UE. El texto completo de la declaración UE de conformidad está disponible en la dirección Internet siguiente: [www.fronius.com](http://www.fronius.com)

**HU:** Fronius International GmbH igazolja, hogy a Fronius Smart Meter IP típusú rádióberendezés megfelel a 2014/53/EU irányelvnek. Az EU-megfelelőségi nyilatkozat teljes szövege elérhető a következő internetes címen: [www.fronius.com](http://www.fronius.com)

**PL:** Fronius International GmbH niniejszym oświadcza, że typ urządzenia radiowego Fronius Smart Meter IP jest zgodny z dyrektywą 2014/53/UE. Pełny tekst deklaracji zgodności UE jest dostępny pod następującym adresem internetowym: [www.fronius.com](http://www.fronius.com)

**UK:** Компания Fronius International GmbH підтверджує, що радіобладнання типу Fronius Smart Meter IP відповідає вимогам директиви 2014/53/EU Ради ЄС і Європейського парламенту. Повний текст сертифіката відповідності вимогам ЄС викладено на сайті [www.fronius.com](http://www.fronius.com).

**RO:** Prin prezenta, FRONIUS INTERNATIONAL GMBH declară că tipul de echipamente radio FRONIUS PRIMO GEN24 este în conformitate cu Directiva 2014/53/UE. Textul integral al declarației UE de conformitate este disponibil la următoarea adresă internet: [www.fronius.com](http://www.fronius.com)

**CS:** Společnost Fronius International GmbH tímto prohlašuje, že typ rádiového systému Fronius Smart Meter IP odpovídá směrnici 2014/53/EU. Úplný text prohlášení o shodě EU je dostupný na internetové adrese [www.fronius.com](http://www.fronius.com).

**DA:** Fronius International GmbH erklærer hermed at radioenhedstypen Fronius Smart Meter IP opfylder direktivet 2014/53/EU. EU-overensstemmelseserklæringen kan i sin fulde tekst ses på følgende adresse: [www.fronius.com](http://www.fronius.com)

**EL:** Διά του παρόντος, η Fronius International GmbH δηλώνει ότι ο τύπος συστήματος Fronius Smart Meter IP συμμορφώνεται με τις απαιτήσεις της οδηγίας 2014/53/ΕΕ. Μπορείτε να βρείτε το πλήρες κείμενο της δήλωσης συμμόρφωσης ΕΕ στην παρακάτω διεύθυνση Internet: [www.fronius.com](http://www.fronius.com)

**FI:** Fronius International GmbH vakuuttaa täten, että radiolaitetyypin Fronius Smart Meter IP on direktiivin 2014/53/EU mukainen. EU-vaatimustenmukaisuusvakuutuksen täydellinen teksti on saatavilla seuraavassa internetosoitteessa: [www.fronius.com](http://www.fronius.com)

**NL:** Fronius International GmbH verklaart hierbij dat het radiosysteem Fronius Smart Meter IP voldoet aan Richtlijn 2014/53/EU. De volledige tekst van de EU-conformiteitsverklaring is beschikbaar op het volgende internetadres: [www.fronius.com](http://www.fronius.com)

**SK:** Spoločnosť Fronius International GmbH týmto vyhlasuje, že rádiové zariadenie typu Fronius Meter IP spĺňa smernicu 2014/53/EÚ. Úplný text vyhlásenia EÚ o zhode je k dispozícii na nasledujúcej internetovej adrese: <http://www.fronius.com>

**SV:** Fronius International GmbH förklarar härmed att radioutrustningen Fronius Smart Meter IP uppfyller direktivet 2014/53/EU. Den fullständiga EU-konformitetsförsäkran finns på följande webbplats: [www.fronius.com](http://www.fronius.com)

**TR:** Fronius International GmbH, işbu dokümanla Fronius Smart Meter IP radyo sistemi tipinin 2014/53/EU Direktifine uygun olduğunu beyan eder. AB uygunluk bildiriminin tam metni aşağıdaki internet adresinde mevcuttur: [www.fronius.com](http://www.fronius.com)

Technical Data	
Permitted ambient temperature	from -25° to +55°C
Nominal frequency	50- 60 Hz
Voltage phase / neutral	100 - 240 V
Voltage phase / phase	208 - 480 V
Self-consumption	max. 5 W
Primary current	5 kA
IP range	IP20 / IP30 (Housing / Connections)
Footprint	3 TE (3 Modules DIN 43880)

Communication	
WLAN / LAN	Modbus TCP
WLAN frequency band	2,4 GHz
RS 485	Modbus RTU
Terminating resistor for RS 485	Configurable 0-1
BIAS Network for RS 485	Configurable 0-1
Multimetering	Yes - up to 2 Smart meters (RTU) Modbusinterface
Addressing (Modbus RTU)	In UI
Update possibility	Yes
CT V (Fronius CT V 100/250/400/600 A)	1 - 5000 A / 333 mV

## LEDs

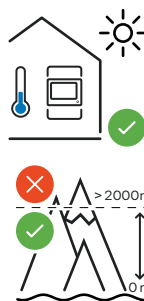
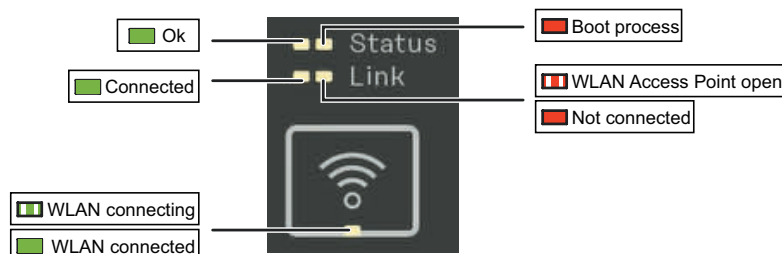

## Software-Version:

Fronius GEN24 & Tauro  
Full Compatibility (Version ≥ 1.24.1)

Fronius Datamanager 2.0 (SnapInverter)  
Modbus RTU (Version ≥ 3.25.1)  
Full Compatibility (Version ≥ 3.28.1)

Fronius Symo Hybrid  
Modbus RTU (Version ≥ 1.25.1)  
Full Compatibility (Version ≥ 1.28.1)

## AC~

1

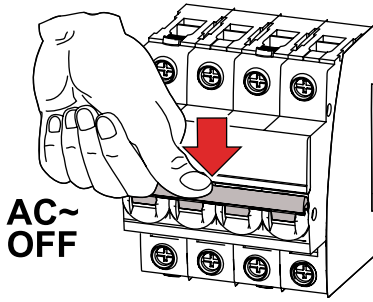

## Mounting

2

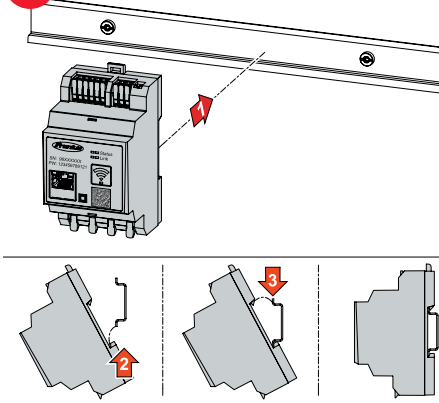

## Power wiring

3

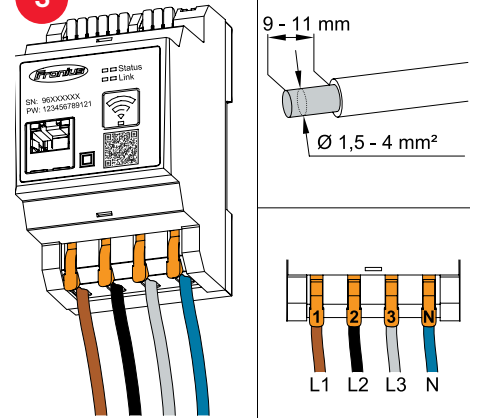

4

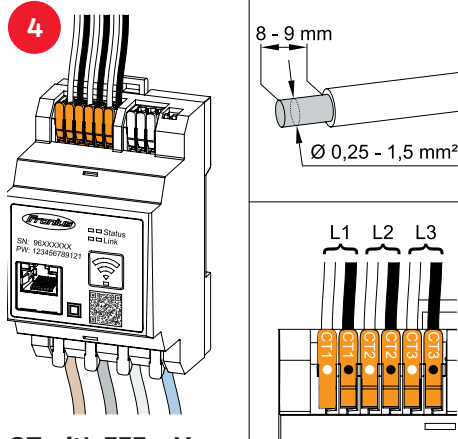

**CT with 333 mV**  
eg: Fronius CT V 100A/333mV

5a 3 Phases,  
4 Wires - CT

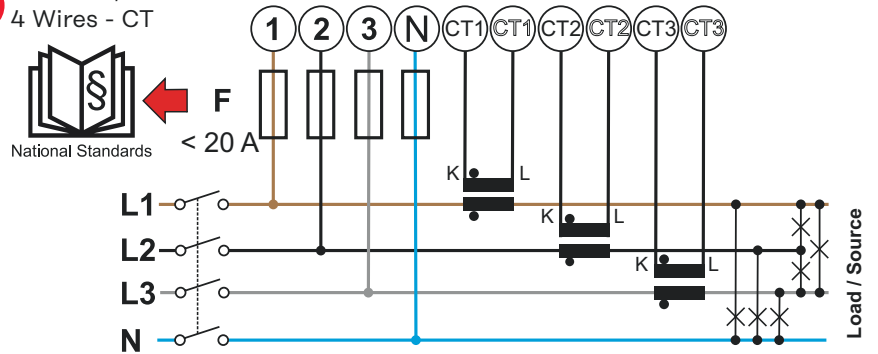

5b 1 Phase, 2 Wires - CT

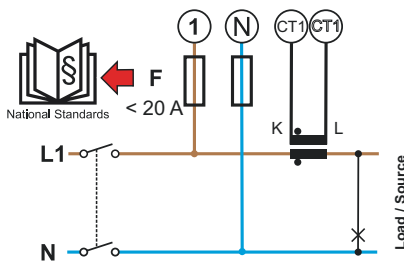

5c 2 Phases, 3 Wires - CT

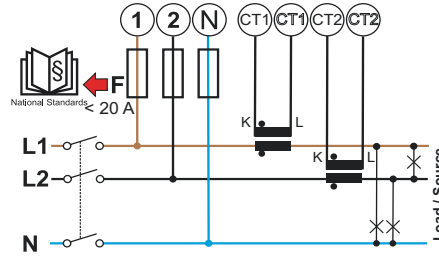

## Data wiring

6a LAN

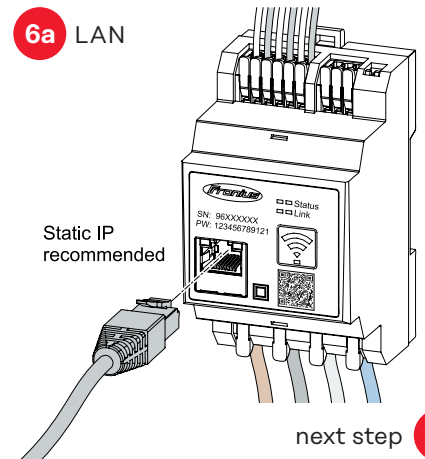

6b WLAN

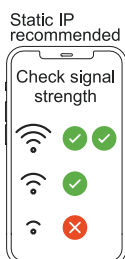

**Technical Data (WLAN)**  
Frequency band: channel 1-14 (2412-2472 MHz)  
Radio-frequency power: <100 mW (<20 dBm)  
Max. antenna gain: 5.3 db  
Separation distance: 20 cm

next step 9

6c Modbus RTU

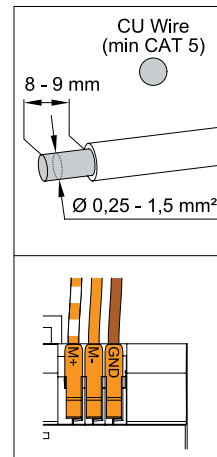
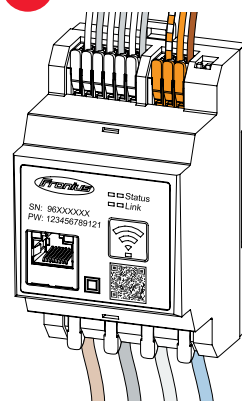

SnapInverter		
Smart Meter	Modbus	
	M+	D+
	M-	D-
	GND	-

GEN24		
Smart Meter	Modbus	
	M+	MO+
	M-	MO-
	GND	GND

## Modbus RTU BIAS

7

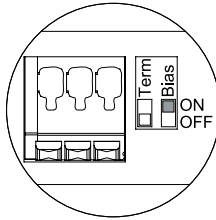

1 = ON ✓  
0 = OFF

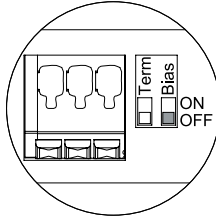

1 = ON  
0 = OFF ✓

## Modbus RTU Terminating Resistor

8a

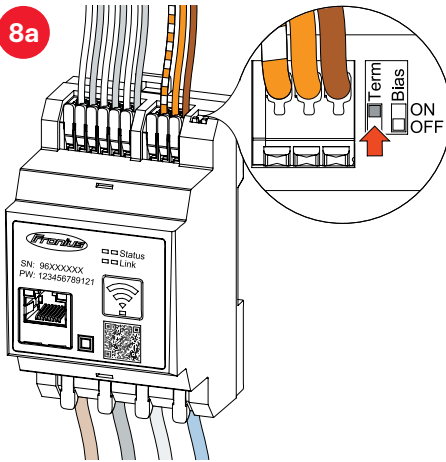

8b

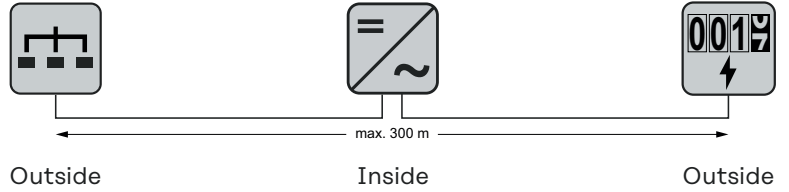
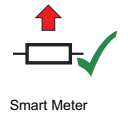
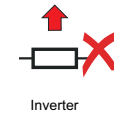
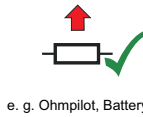
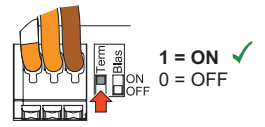

## AC~

9

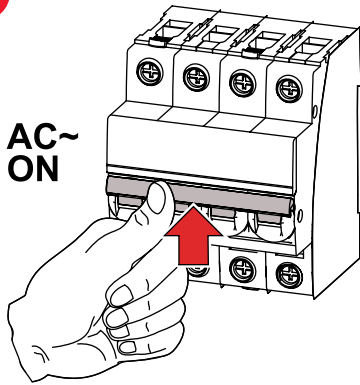

## Setup

10a Mobile phone



Scan QR-Code



Follow instructions  
Initial password for UI: 123

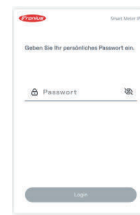

10b PC



Connect to access point  
SSID = *FroniusMeter\_XXXXX*  
(xxx = Serial number)  
Password = see Smart Meter (PW)

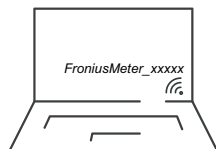

Open  
IP WLAN:  
192.168.250.181



Follow instructions  
Initial password for UI: 123

