

Smart
connections.

Operating manual

PIKO inverter
3.0 - 20

Legal notice

KOSTAL Solar Electric GmbH
Hanferstraße 6
79108 Freiburg i. Br.
Germany
Phone +49 (0)761 477 44 - 100
Fax +49 (0)761 477 44 - 111
www.kostal-solar-electric.com

Exclusion of liability

All names, trademarks, product names or other designations used in this manual may be legally protected even if not indicated as such (e.g. as a trademark). KOSTAL Solar Electric GmbH assumes no liability or warranty for their free usage. The illustrations and texts have been compiled with great care. However, the possibility of errors cannot be ruled out. The compilation is made without any guarantee.

General note on gender equality

KOSTAL Solar Electric GmbH is aware of the importance of language with regard to the equality of women and men and always makes an effort to reflect this in the documentation. Nevertheless, for the sake of readability we are unable to use non-gender-specific terms throughout and use the masculine form instead.

© 2017 KOSTAL Solar Electric GmbH

All rights reserved by KOSTAL Solar Electric GmbH, including those of reproduction by photocopy and storage in electronic media. Commercial use or distribution of the texts, displayed models, diagrams and photographs appearing in this product is not permitted. This manual may not be reproduced, stored, transmitted or translated in any form or by means of any medium, in whole or in part, without prior written permission.

Software version as of FW: 05.50
User Interface (UI) as of: 06.30

Contents

1.	General information	6
1.1	Proper use	8
1.2	EU declarations of conformity	10
1.3	About this manual	11
1.4	Notes in this manual	13
1.5	Symbols used	17
1.6	Labels on the inverter	18
2.	Device and system description	19
2.1	The photovoltaic system	20
2.2	Inverter components	22
2.3	Inverter functions	38
3.	Installation	40
3.1	Transport and storage	41
3.2	Scope of delivery	42
3.3	Installation	44
3.4	Electrical connection	47
3.5	Connection of solar module	50
3.6	Connection of communication components	55
3.7	Initial commissioning	59
4.	Operation and operating the device	62
4.1	Switching on the inverter	63
4.2	Switching off the inverter	64
4.3	De-energising the inverter	65
4.4	Control panel	66
4.5	Operational status (display)	69
4.6	Operational status (LEDs)	70
4.7	The menu structure of the inverter	71
4.8	The service menu	76
4.9	The energy management system in the inverter	77
4.10	Event codes	78

5.	Webserver	86
5.1	The Webserver	87
5.2	Using the Webserver	88
5.3	Connecting the inverter and computer	89
5.4	Menu structure in web browser	91
5.5	Webserver main menu	93
5.6	Webserver submenus	94
6.	System monitoring	106
6.1	Create connection between computer and inverter	107
6.2	The log data	110
6.3	Retrieve, save and graphically represent log data	113
7.	Active power control	116
7.1	Why active power control?	117
7.2	Limitation of the PV feed-in capacity	118
7.3	Activate power control with a ripple control receiver	119
7.4	Install the ripple control receiver	120
8.	Self-consumption	123
8.1	Self-consumption overview	124
8.2	Electrical connection for self-consumption	125
8.3	Set up self-consumption control in the Webserver	126
9.	Maintenance	133
9.1	Maintenance and service	134
9.2	Fan cleaning	135
9.3	Update software (communication board)	139
9.4	Update software (inverter firmware)	141
9.5	Update software (country settings)	142

10. Technical data	143
10.1 Technical data	145
10.2 Block diagram	152
11. Accessories	153
11.1 Installation of PIKO BA Sensor	154
11.2 Operating the system with multiple inverters and PIKO BA Sensor	159
11.3 Additional accessories	162
12. Appendix	164
12.1 Type plate	165
12.2 Warranty and service	166
12.3 Handover to the operator	167
12.4 Disassembly and disposal	168
Index	169

1. General information

1.1	Proper use	8
1.2	EU declarations of conformity	10
1.3	About this manual	11
1.4	Notes in this manual	13
1.5	Symbols used	17
1.6	Labels on the inverter	18

Thank you for choosing a PIKO inverter from KOSTAL Solar Electric GmbH! We hope you enjoy consistently high energy yields with the PIKO inverter and your photovoltaic system.

If you have any technical questions, please call our service hotline:

- Germany and other countries¹
+49 (0)761 477 44 - 222
- Switzerland
+41 32 5800 225
- France, Belgium, Luxembourg
+33 16138 4117
- Greece
+30 2310 477 555
- Italy
+39 011 97 82 420
- Spain, Portugal²
+34 961 824 927
- Turkey³
+90 212 803 06 26

¹ Language: German, English

² Language: Spanish, English

³ Language: English, Turkish

1.1 Proper use

The PIKO inverter converts direct current into alternating current. This can be used as follows:

- For self-consumption
- For feed-in into the public grid

The device may only be used in grid-connected photovoltaic systems within the permissible power range and under the permissible ambient conditions. The device is not intended for mobile use.

Inappropriate use can be hazardous and lead to injury or even death to the user or third parties. Material damage to the device and other equipment can also occur. The inverter may therefore only be used for its intended purpose.

All components fitted on the inverter or in the PV system must satisfy the standards and guidelines that apply in the country of installation.

Exclusion of liability

Any use that differs from that described in **Ch. 1.1** or goes beyond the stated intended purpose, is considered inappropriate. The manufacturer accepts no liability for any damage resulting from this. Modifications to the inverter are prohibited. The inverter may only be used if it is safe to operate and is in a technically perfect condition. Any instance of misuse will result in the termination of the warranty, guarantee and general liability of the manufacturer.

Only a qualified electrician may open the device. The inverter must be installed by a trained electrician (according to DIN VDE 1000-10 or BGV A3 accident prevention regulations) who is responsible for observing the applicable standards and regulations.

Work that could affect the electrical power system of the relevant energy supply company at the site of the solar power feed-in may only be carried out by qualified electricians expressly authorised (licensed) by the energy supply company. This includes changes to the factory-preset parameters. The installer must always observe the regulations of the energy supply company.

Factory settings may only be changed by qualified electrical installers or persons with at least comparable or higher technical qualifications, e.g. foremen, technicians or engineers. When doing so, all requirements are to be observed.



IMPORTANT INFORMATION

The inverter may only be installed, maintained and repaired by a trained and qualified electrician.

The electrician is responsible for ensuring that the applicable standards and regulations are observed and implemented. Work that could affect the electrical power system of the relevant energy supply company at the site of the solar power feed-in may only be carried out by qualified electricians expressly authorised (licensed) by the energy supply company.

This includes changes to the factory-preset parameters.

1.2 EU declarations of conformity

KOSTAL Solar Electric GmbH hereby declares that the inverter described in this document complies with the basic requirements and other relevant conditions of the directives listed below.

- Directive 2014/30/EU
(on the approximation of the laws of the Member States relating to electromagnetic compatibility (EMC))
- Directive 2014/35/EU
(on the harmonisation of the laws of the Member States relating to the making available on the market of electrical equipment designed for use within certain voltage limits – for short: Low Voltage Directive)
- Directive 2011/65/EU (RoHS)
on the restriction of the use of certain hazardous substances in electrical and electronic equipment

You will find a detailed EU Declaration of Conformity at:

www.kostal-solar-electric.com/Download/Zertifikate

1.3 About this manual

Read this manual carefully in its entirety. 

It contains important information on the installation and operation of the inverter. Pay particular attention to the instructions regarding safe usage. KOSTAL Solar Electric GmbH assumes no liability for damages arising from the non-observance of this manual.

This manual is an integral part of the product. It applies exclusively to the PIKO inverters from KOSTAL Solar Electric GmbH. Keep this manual and give it to the new owner should you pass it onto a new operator.

The installer and the operator must have unrestricted access to these instructions at all times. The installer must be familiar with this manual and follow all instructions.

The most recent version of the operating manual for your product is available in the download area at www.kostal-solar-electric.com.

Target group

This manual is intended for trained and qualified electrical technicians who install, maintain and repair the inverters.

The inverters described in this manual differ from one another in terms of particular technical details. Information and handling instructions that only apply to certain device types are to be identified accordingly.

Information concerning your safety or that of the unit is highlighted especially.



TIP

Print both sides on one sheet of paper when printing out this operating manual.

This saves paper and the document remains easy to read.

Navigation through the document

In order to enable navigation through this document, it contains clickable areas.

One of these is the navigation bar in the header of each page. Here you can go to the overview pages of the individual chapters in one click.

The table of contents can also be used in this way. From the index at the beginning of each chapter you can go to the indicated sub-chapter in one click.

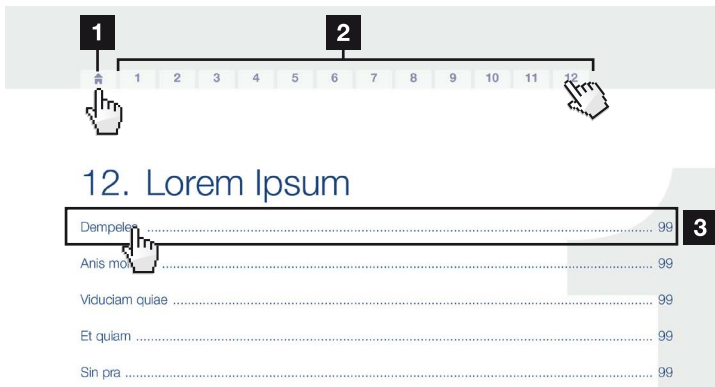

Fig. 1: Navigation through the document

- 1 Calling up the main table of contents
- 2 Navigation bar
- 3 Tables of contents

You can navigate to the referenced points in the document within the instruction text using the cross-references.

Ch. 1

Fig. 1, It. 2

Fig. 2: Examples of cross-references

1.4 Notes in this manual

Installation ⚠️

Installing the wall mount and hanging the inverter

- Mark the positions of the drill holes at the installation site by using the wall mount as a drilling template.
- Drill holes and insert wall anchors if necessary.
- Screw the wall mount to the intended surface.
- Use the supplied screws.

Connecting AC-side ⚠️

We recommend a mains cable with the cross-section $3 \times 2.5 \text{ mm}^2$. The outer diameter of the cable can be 9...17 mm, the cross-section of the individual conductors can be a max. of 4 mm^2 for flexible cables and a max. of 6 mm^2 for rigid cables. For flexible cables, we recommend using core end sleeves.

Remove the sheath and the insulation of the mains cable as much as needed.

First thread the unscrewed union nut and then the sealing ring over the cable. ⓘ

2 **DANGER**

Risk of death due to electrical shock
Always disconnect the device from the power supply during installation and before maintenance and repairs and lock it to prevent it being switched back on.

3 **IMPORTANT NOTE**

Press the blind plug and the sealing ring out of the screw connection from the inside outwards using a screwdriver or similar implement.

4 **NOTE**

To connect the AC and DC cables, the inverter is equipped with spring-loaded terminal strips.

Fig. 3: Safety instructions in this manual

- 1** Reference icon within the instruction text
- 2** Warning
- 3** Information note
- 4** Other notes

Notes have been incorporated into the instruction text. A differentiation is made in this manual between warnings and information notes. All notes are identified in the text line with an icon.

Warnings

The warnings refer to life-threatening dangers. Serious injuries possibly resulting in death may occur.

Each warning consists of the following elements:

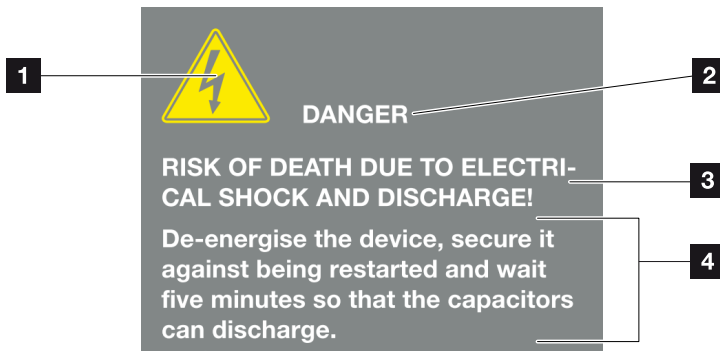

Fig. 4: Structure of the warnings

- 1 Warning symbol
- 2 Signal word
- 3 Type of danger
- 4 Corrective actions

Warning symbols



Danger



Danger due to electrical shock and discharge



Danger due to electromagnetic fields



Danger due to burns

Signal words

Signal words are used to identify the severity of the danger.

DANGER

Indicates a direct hazard with a high level of risk, which, when it is not avoided, can result in death or serious injury.

WARNING

Indicates a hazard with a moderate level of risk, which, when it is not avoided, can result in death or serious injury.

CAUTION

Indicates a hazard with a low level of risk, which, when it is not avoided, can result in minor or slight injury or property damage.

Information notes

Information notes contain important instructions for the installation and problem-free operation of the inverter. These must be followed at all times. The information notes also point out that failure to observe may result in damage to property or financial damages.

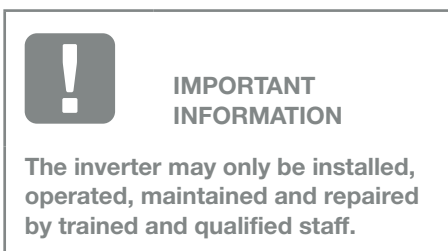

Fig. 5: Example of an information note

Symbols within the information notes



Important information



Damage to property possible

Other notes

They contain additional information or tips.



INFO

This is additional information.

Fig. 6: Example of an information note

Symbols within the additional notes



Information or tip



Enlarged view

1.5 Symbols used

Symbol	Meaning
1., 2., 3. ...	Sequential steps in a handling instruction
→	Effect of a handling instruction
✓	Final result of a handling instruction
☒	Cross-reference to other places in the document or to other documents
■	List

Tab. 1: Symbols and icons used

Abbreviations used

Abbreviation	Explanation
Tab.	Table
Fig.	Figure
It.	Item
Ch.	Chapter

1.6 Labels on the inverter

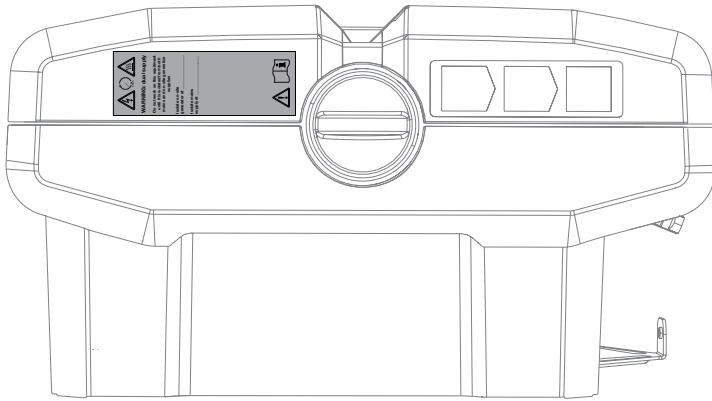









Fig. 7: Labels on the inverter – Figure example

Signs and labels are applied to the housing of the inverter. These signs and labels may not be altered or removed.

Symbol	Explanation
	Danger due to electrical shock and discharge
	Danger due to electrical shock and discharge. Wait five minutes (discharge time of the capacitors) after shut-down
	Danger due to burns
	Danger notice
	Additional earth connection
	Observe and read operating manual
	Device may not be disposed of with household waste. Observe the local application of disposal requirements

2. Device and system description

2.1	The photovoltaic system	20
2.2	Inverter components	22
2.3	Inverter functions	38

2.1 The photovoltaic system

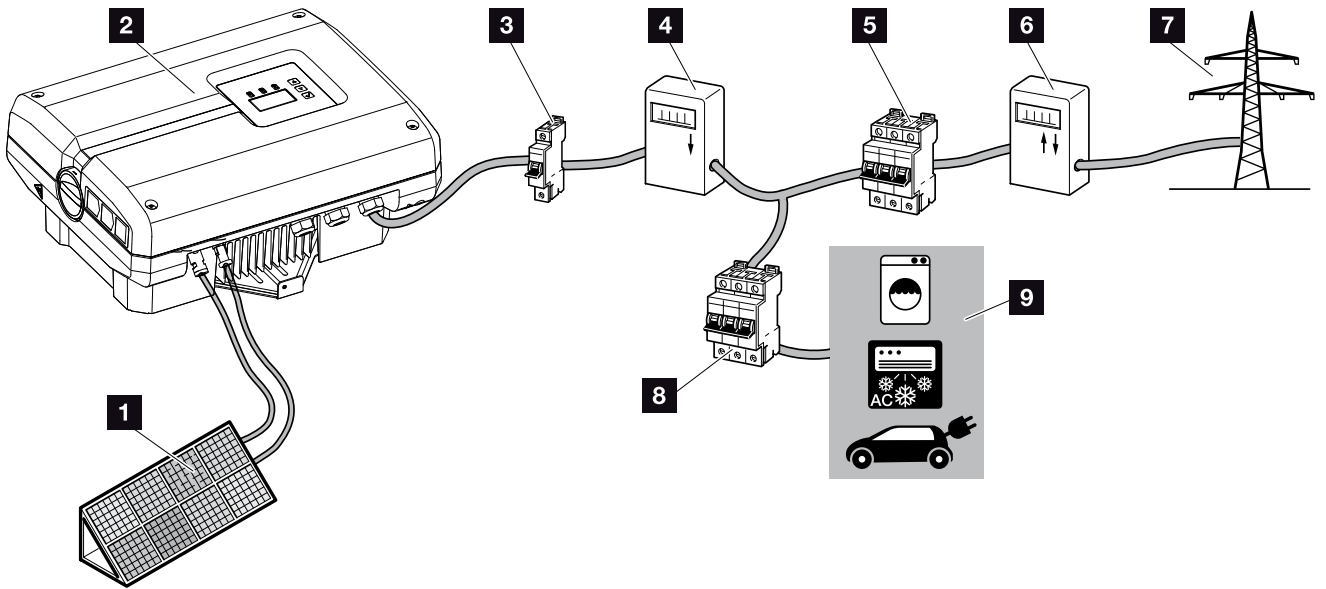

Fig. 8: Photovoltaic system 1-phase

- 1** PV string
- 2** Inverter
- 3** Line circuit breaker for inverter
- 4** PV yield counter (optional)
- 5** Line circuit breaker for house
- 6** Feed-in procurement meter
- 7** Public grid
- 8** Line circuit breaker for energy consumers
- 9** Energy consumers

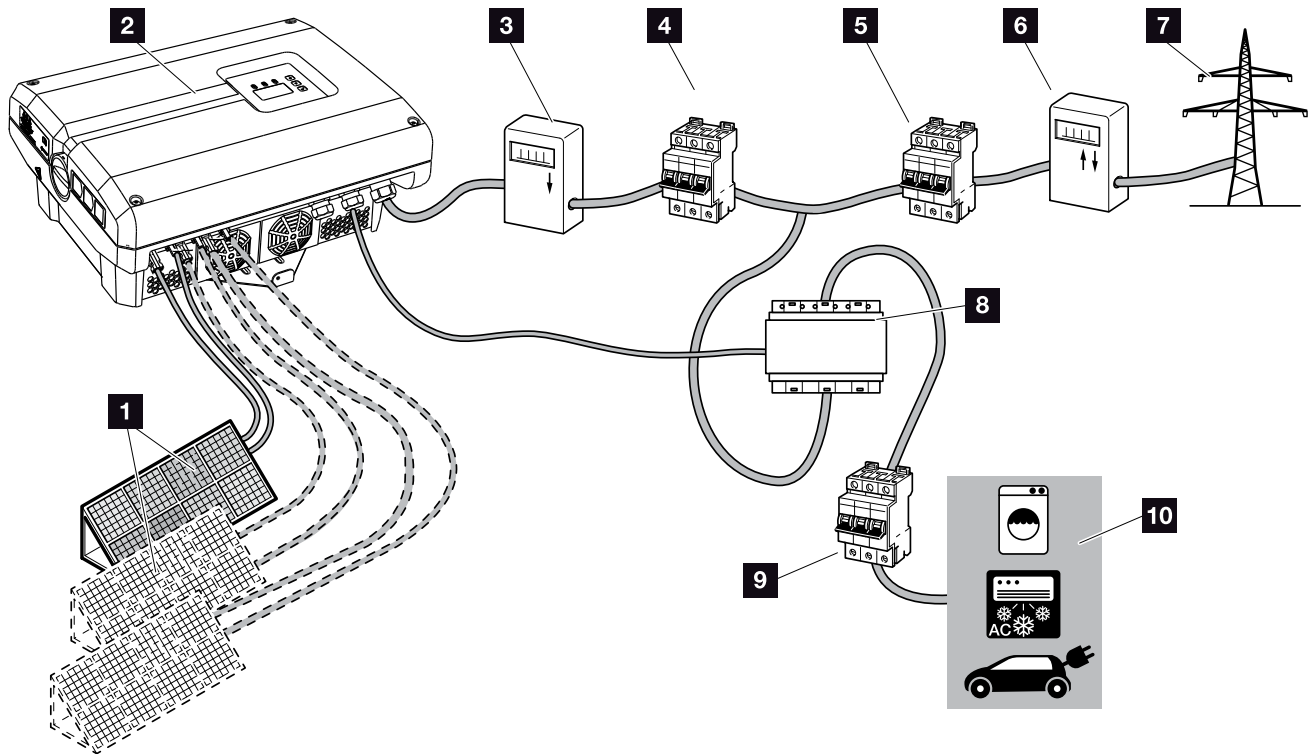

Fig. 9: Photovoltaic system 3-phase

- 1 PV string (2+3 optional)
- 2 Inverter
- 3 PV yield counter (optional)
- 4 Line circuit breaker for inverter
- 5 Line circuit breaker for house
- 6 Feed-in procurement meter
- 7 Public grid
- 8 PIKO BA Sensor (optional accessory)
- 9 Line circuit breaker for consumers
- 10 Energy consumers

2.2 Inverter components

Exterior view of the inverter

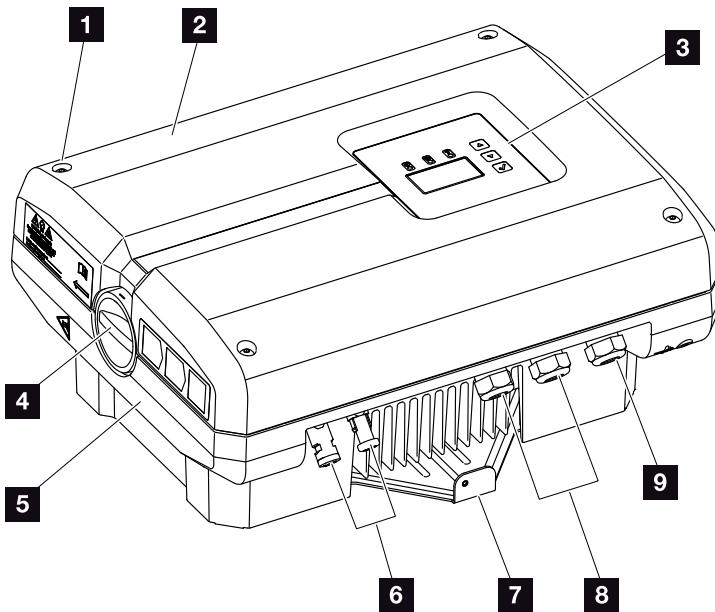

Fig. 10: PIKO inverter 3.0 (exterior view)

- 1** Cover screws
- 2** Cover
- 3** Display
- 4** DC switch
- 5** Housing
- 6** Plug connector or cable openings to connect the solar modules
- 7** Wall mount
- 8** Cable openings for optional communication
- 9** Opening for the mains cable

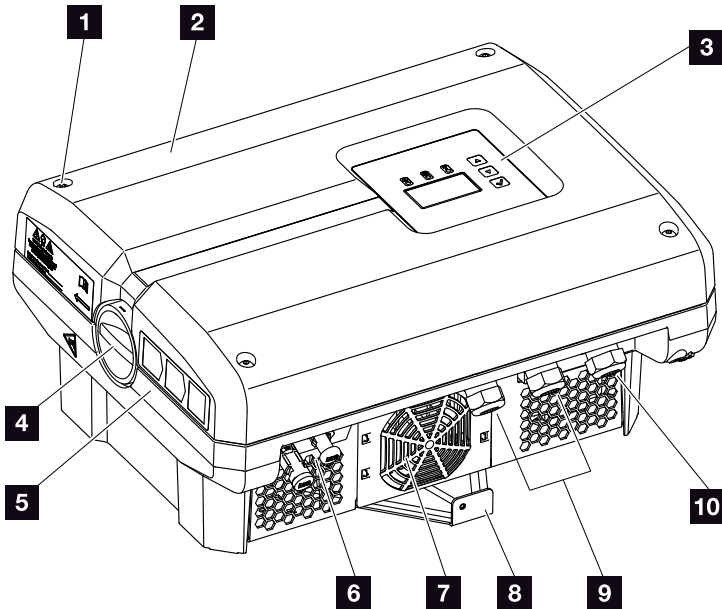

Fig. 11: PIKO inverter 4.2 (exterior view)

- 1** Cover screws
- 2** Cover
- 3** Display
- 4** DC switch
- 5** Housing
- 6** Plug connector or cable openings to connect the solar modules
- 7** Fan grill (without fan)
- 8** Wall mount
- 9** Cable openings for optional communication
- 10** Opening for the mains cable

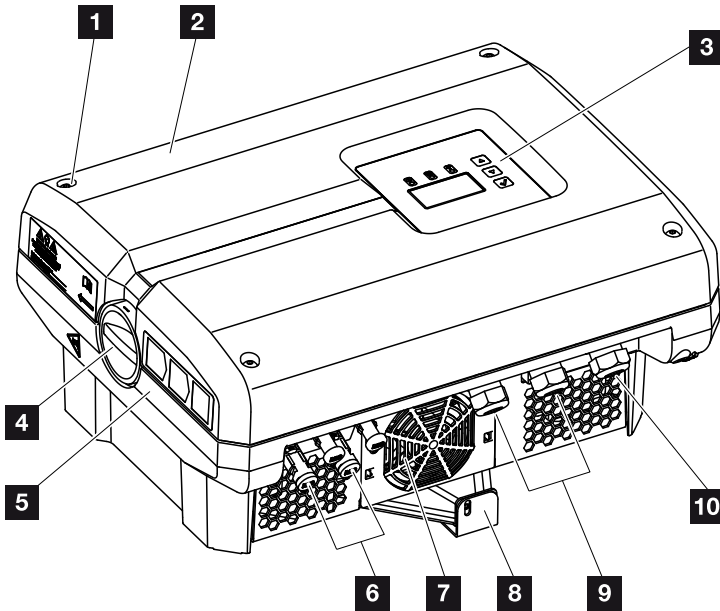

Fig. 12: PIKO inverters 4.6 - 8.5 (exterior view)

- 1 Cover screws
- 2 Cover
- 3 Display
- 4 DC switch
- 5 Housing
- 6 Plug connector or cable openings to connect the solar modules
- 7 Fan
- 8 Wall mount
- 9 Cable openings for optional communication
- 10 Opening for the mains cable

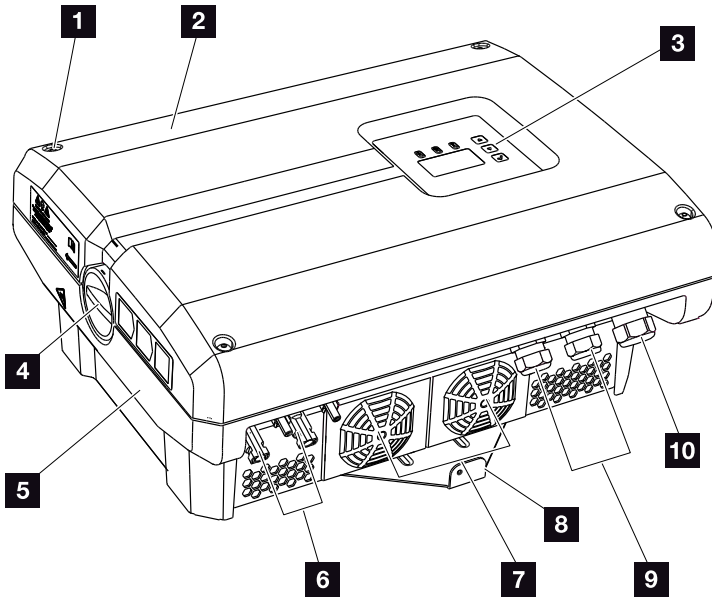

Fig. 13: PIKO inverters 10 - 12 (exterior view)

- 1** Cover screws
- 2** Cover
- 3** Display
- 4** DC switch
- 5** Housing
- 6** Plug connector or cable openings to connect the solar modules
- 7** Fan
- 8** Wall mount
- 9** Cable openings for optional communication
- 10** Opening for the mains cable

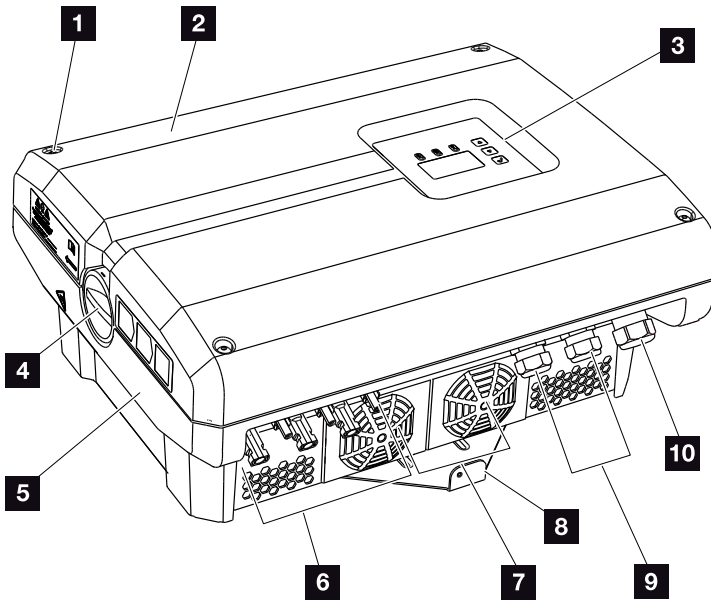

Fig. 14: PIKO inverters 15 - 20 (exterior view)

- 1** Cover screws
- 2** Cover
- 3** Display
- 4** DC switch
- 5** Housing
- 6** Plug connector or cable openings to connect the solar modules
- 7** Fan
- 8** Wall mount
- 9** Cable openings for optional communication
- 10** Opening for the mains cable

DC switch on the inverter

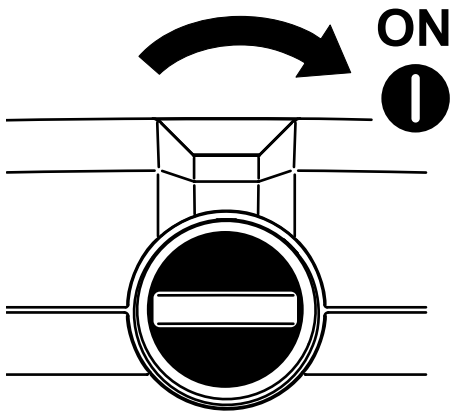

Fig. 15: DC switch ON

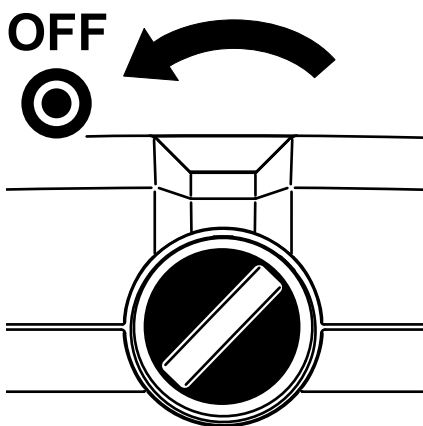

Fig. 16: DC switch OFF

Interior view of the inverter

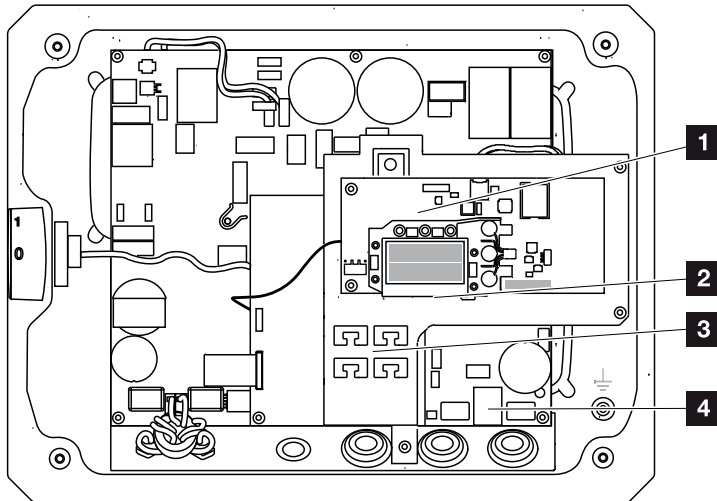

Fig. 17: PIKO inverter 3.0 (interior view)

- 1 Communication board
- 2 Ethernet connections (RJ45)
- 3 Cable tray with fastening openings
- 4 AC terminal

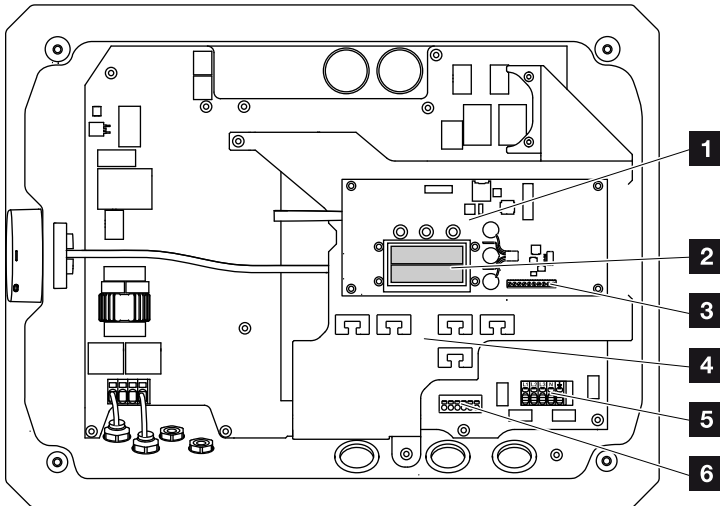

Fig. 18: PIKO inverter 4.2 (interior view)

- 1 Communication board
- 2 Ethernet connections (RJ45)
- 3 Terminal for analog interface and RS485
- 4 Cable tray with fastening openings
- 5 AC terminal
- 6 Terminal for sensor lines of PIKO BA Sensor

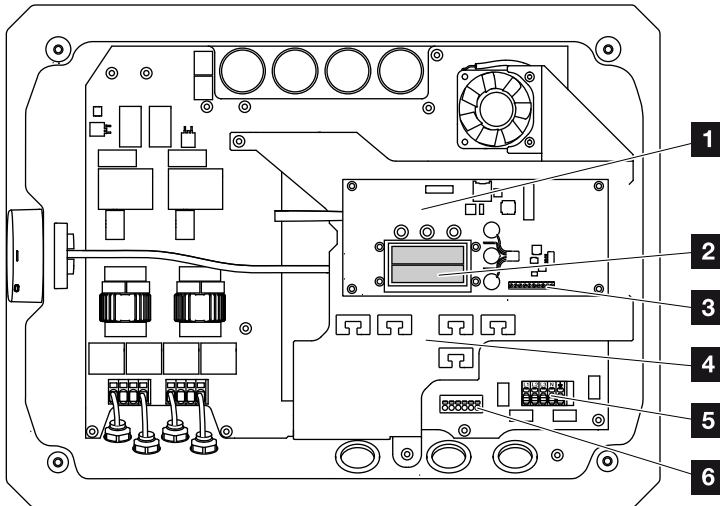

Fig. 19: PIKO inverters 4.6-8.5 (interior view)

- 1 Communication board
- 2 Ethernet connections (RJ45)
- 3 Terminal for analog interface and RS485
- 4 Cable tray with fastening openings
- 5 AC terminal
- 6 Terminal for sensor lines of PIKO BA Sensor

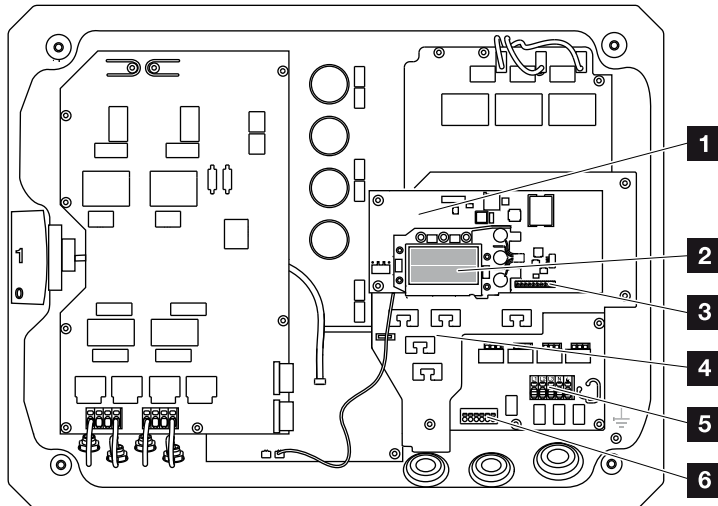

Fig. 20: PIKO inverters 10 - 12 (interior view)

- 1** Communication board
- 2** Ethernet connections (RJ45)
- 3** Terminal for analog interface and RS485
- 4** Cable tray with fastening openings
- 5** AC terminal
- 6** Terminal for sensor lines of PIKO BA Sensor

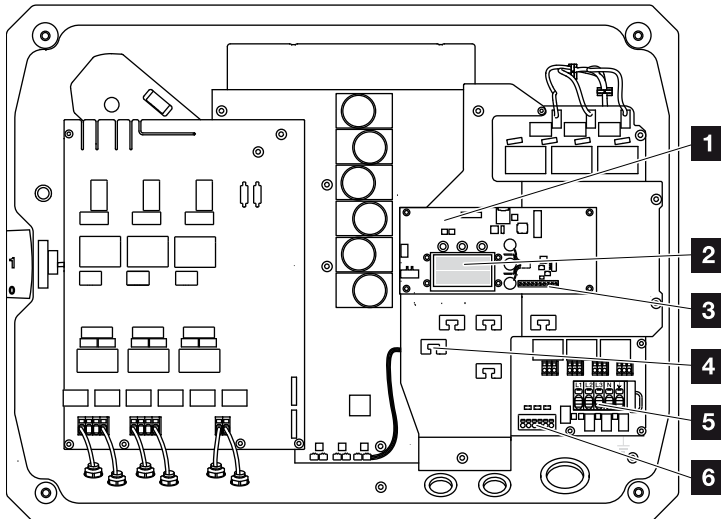

Fig. 21: PIKO inverters 15 - 20 (interior view)

- 1** Communication board
- 2** Ethernet connections (RJ45)
- 3** Terminal for analog interface and RS485
- 4** Cable tray with fastening openings
- 5** AC terminal
- 6** Terminal for sensor lines of PIKO BA Sensor

The communication board

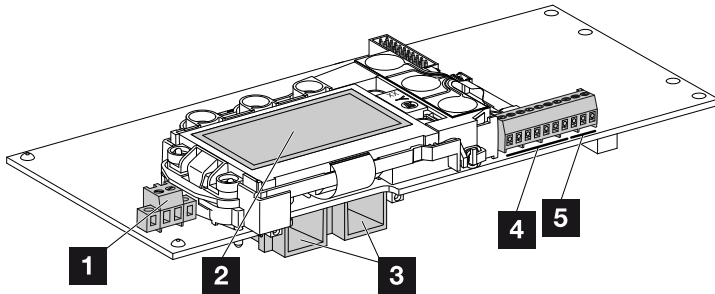

Fig. 22: Components of the communication board

- 1** Terminal S0/AL-Out (2-pin)
- 2** Display
- 3** 2 Ethernet connections (RJ45)
- 4** Analog interface terminal
- 5** RS485 terminal

The communication board is the communications centre of the inverter. The connections for communication, the display and the control buttons are found on the communication board.

The control panel

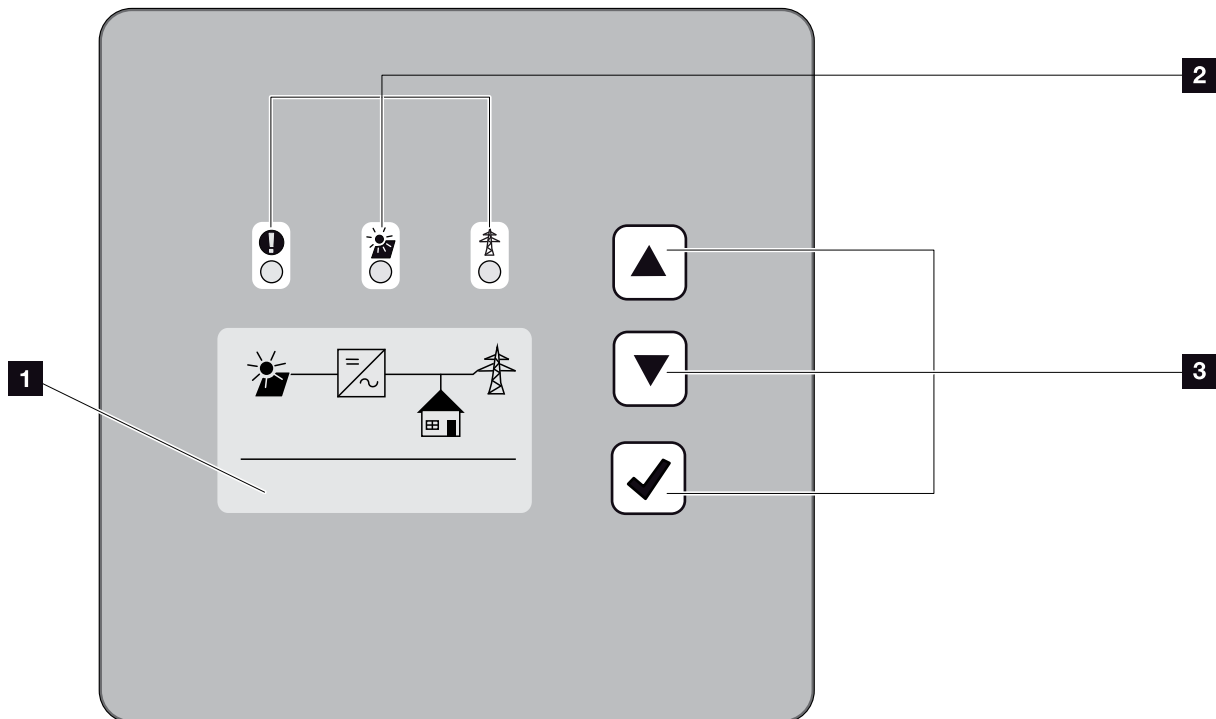

Fig. 23: Control panel

- 1** Display (display dependent upon the inverter type. Here it is the menu of the 3-phase inverter).
- 2** LEDs for displaying the operational status
- 3** Control buttons

Adjustments can be made and data retrieved via the control panel. Event messages are shown on the display.

The main menu

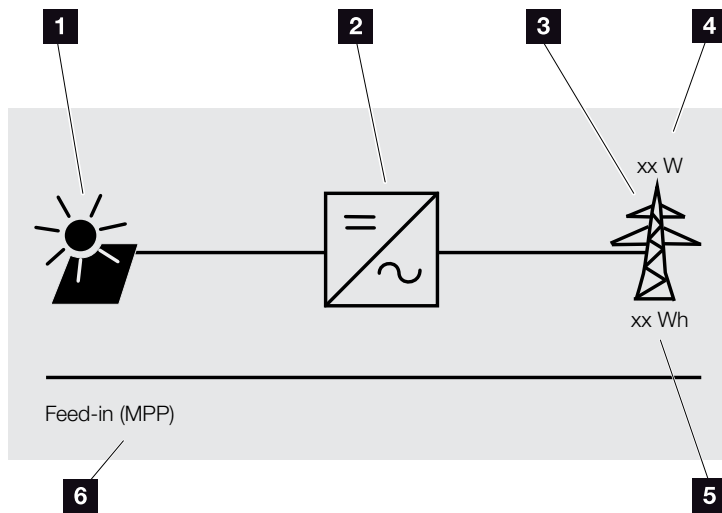

Fig. 24: Main menu: 1-phase

- 1 "DC" menu
- 2 "Settings" menu
- 3 "AC" menu
- 4 Current AC power
- 5 Fed-in daily yield
- 6 Operational status display

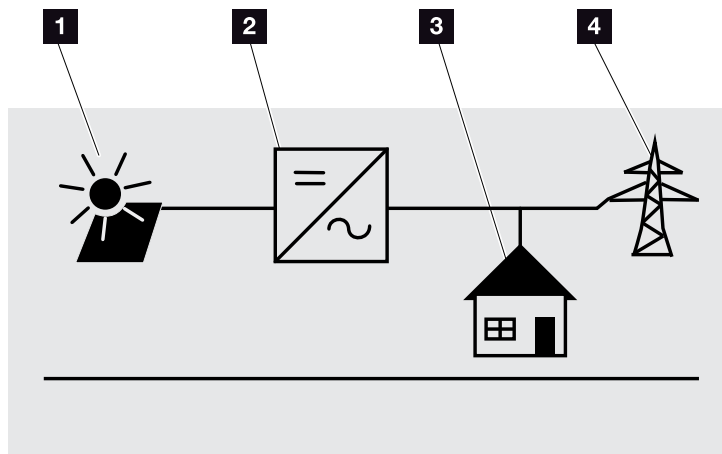



Fig. 25: Main menu: 3-phase

- 1 "DC" menu
- 2 "Settings" menu
- 3 "Self-consumption" menu
- 4 "AC" menu

The Webserver

The Webserver is a graphic interface (representation in the browser) for the retrieval and configuration of the inverters. It offers the following content:

Ch. 5.1

Webserver pages	Function
Home	Displays inverter status and current yield values
Current values	Displays the current values of the PV generators, home consumption, mains connection, analogue interfaces and the use of the SO/AL-Out terminal on the communication board.
Statistics	Displays yield and consumption for day or total and log data.
Settings	Inverter configuration
Info	Displays all inverter events and version numbers (e.g. user interface, firmware, hardware). You can also view these version numbers without logging in to the Webserver.
Login/Logout	Login: Page for logging in to Webserver. You can log in as a plant owner or as an installer.  Logout: Menu item to log out of the Webserver.



INFO

You need a service code to log in as an installer. This can be obtained from the service team.  Ch. 12.2

Tab. 2: Overview of the Webserver pages

The data logger

A data logger is integrated in the PIKO inverter. The data logger is a data storage system for the yield and performance data of the inverter and the storage system. Yield data (saving interval) can be saved every 5, 15 or 60 minutes. The data logger is set in the factory to a saving interval of 15 minutes. The saving interval can be changed at the "Settings" <page. 

Saving interval	Saving time
5 minutes	Max. 130 days
15 minutes	Max. 400 days
60 minutes	Max. 1500 days

Tab. 3: Saving intervals of data logger



INFO

Pay attention to the memory storage time when selecting the saving interval!

When the internal memory is full, the oldest data will be overwritten. For long-term backup, the data must be backed up with a PC or sent to a solar portal.

2.3 Inverter functions

Shadow management

If a connected PV string is subjected to partial shading, e.g. caused by other parts of a building, trees or power lines, the entire PV string no longer achieves its optimum performance. The PV modules affected behave like a bottleneck and thereby prevent better performance.

The intelligent shadow management integrated in the PIKO inverter now adapts the MPP tracker of the selected string so that the PV string can always deliver optimum performance in spite of partial shading.

For more information  **Ch. 5.6**

External module control

The PIKO inverter allows PV modules with their own MPP tracker control to be connected. With this kind of PV module, the performance of every single module is optimised so that they all deliver optimum performance. The PIKO inverter allows such PV modules to be connected and adapts its own control to this.

For more information  **Ch. 5.6**

Recording home consumption

By connecting the optional PIKO BA Sensor, the inverter can control and record the energy flow in the building in an optimum manner. The control and distribution of energy between the DC side (solar generator) and the AC side (building grid, public grid) is thereby carried out by the energy management system (EMS) of the PIKO inverter. To this purpose, the EMS uses the PIKO BA Sensor to check whether consumption is taking place in the internal home network. The logic of the EMS then uses this to calculate and control the optimal usage of PV energy.

You will find more information about using the PIKO BA Sensor in  **Ch. 11.1.**

3. Installation

3.1	Transport and storage	41
3.2	Scope of delivery	42
3.3	Installation	44
3.4	Electrical connection	47
3.5	Connection of solar module	50
3.6	Connection of communication components	55
3.7	Initial commissioning	59

3.1 Transport and storage

The function of the inverter has been tested, and it has been carefully packaged prior to delivery. Upon receipt, check the delivery for completeness and any transport damage. 📦

Complaints and damage claims are to be directly addressed to the shipping company.

If stored for a longer period before installation, all components of the inverter must be kept dry and dust-free in the original packaging.

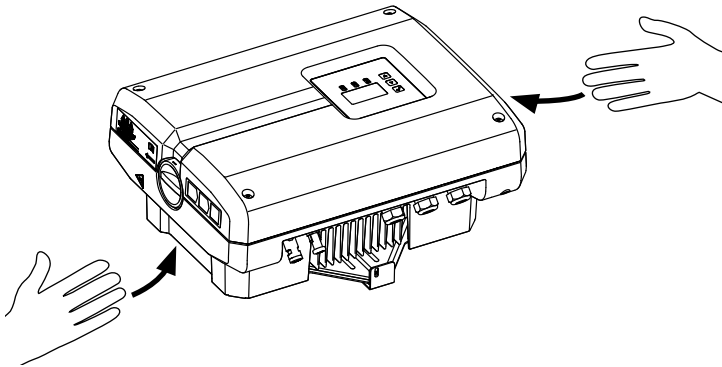

Fig. 26: Recessed grips on inverter

Recessed grips have been integrated to the left and right for better transport of the inverter.



DAMAGE POSSIBLE

Risk of damage when the inverter is placed on its underside. Always place the inverter on its rear side (cooling elements) after unpacking.

3.2 Scope of delivery

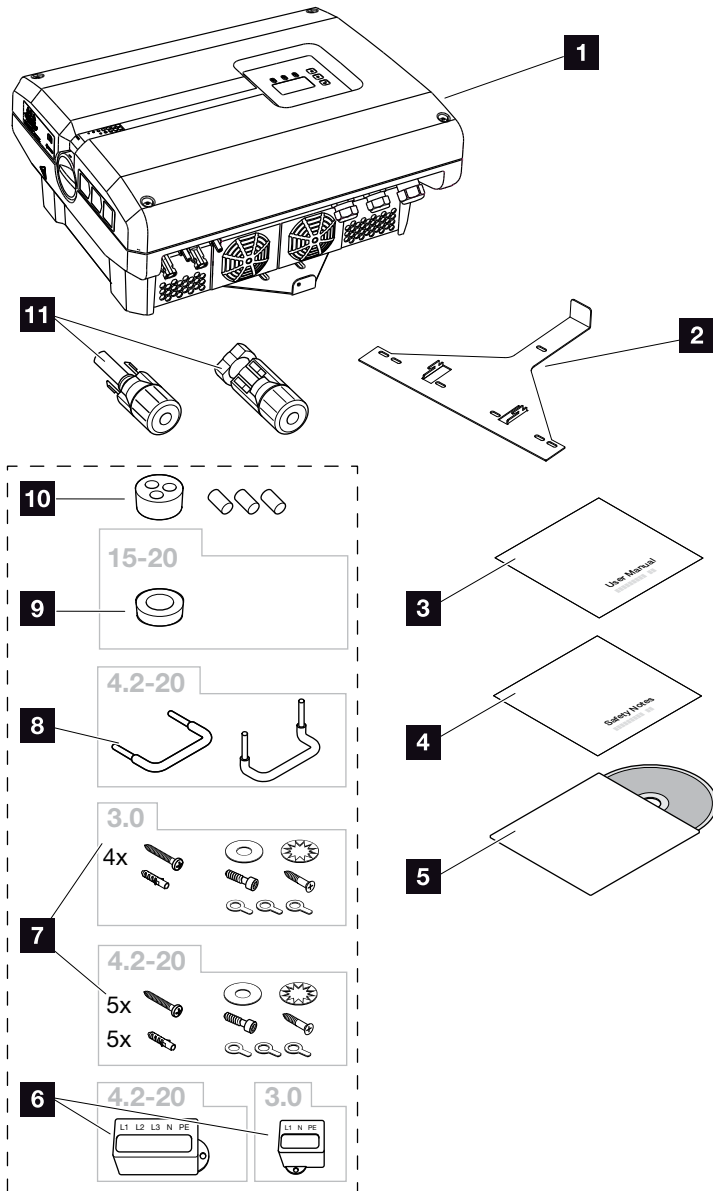

Fig. 27: Scope of delivery of PIKO 3.0, 4.2-20

The packaging contains:

- 1** 1 x inverter
- 2** 1 x wall mount (not for replacement devices)
- 3** 1 x Short Manual
- 4** 1 x Safety Notes
- 5** 1 x CD with operating manual
- 6** 1 x sealing cap (3-pin or 5-pin) for sealing the AC terminal

7 Installation accessories for PIKO 3.0:

- 4 x screws 6x45 A2 DIN 571,
- 4 x screw anchors 8x40,
- 1 x tapping screw M4x10 Form A galvanised DIN 7516,
- 1 x fan washer 12x6.4 A2 DIN 6798,
- 1 x plain washer 12x6.4 A2 DIN 125,
- 1 x cylinder bolt M6x12 A2 ISO 4762
- 1 x ring terminal M6x16 mm²,
- 1 x ring terminal M6x10 mm²,
- 1 x ring terminal M6x6 mm²

Installation accessories for PIKO 4.2-20:

- 5 x screws 6x45 A2 DIN 571,
- 5 x screw anchors 8 x40 mm,
- 1 x tapping screw M4x10 Form A galvanised DIN 7516,
- 1 x fan washer 12x6.4 A2 DIN 6798,
- 1 x plain washer 12x6.4 A2 DIN 125,
- 1 x cylinder bolt M6x12 A2 ISO 4762
- 1 x ring terminal M6x16 mm²,
- 1 x ring terminal M6x10 mm²,
- 1 x ring terminal M6x6 mm²

- 8** 2 x wire jumpers for parallel connection (type-dependent)

9 Installation accessories for PIKO 15-20:

Plug seals for screw attachment of AC cable with a max. diameter of 14.5 mm

- 10** Plug seals for the screw connection of the network cable

- 11** DC plug connector (each DC input: 1x plug, 1x socket)

3.3 Installation

Selecting the installation site



Protect inverter from rain and splash water.

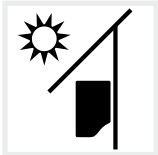

Protect inverter against exposure to direct sunlight.

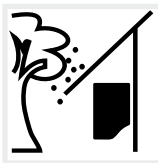

Protect inverter from falling parts which could enter the inverter's ventilation openings. 

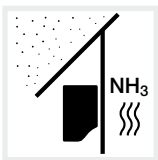

Protect the inverter against dust, contamination and ammonia gases. Rooms and areas containing livestock are not permitted as installation locations.

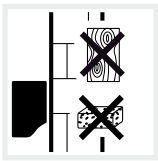

Mount inverter on a stable installation surface that can safely bear the weight. Plasterboard walls and wood planking are not permitted.



Mount inverter on a non-flammable installation surface. 

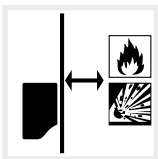

A sufficient safety distance from flammable materials and explosion hazard areas in the vicinity must be ensured.



IMPORTANT INFORMATION

Observe these instructions when selecting the installation location. Guarantee claims may be restricted or become entirely null and void in the event of failure to observe.



DAMAGE POSSIBLE

Falling parts that enter the fan through the inverter's ventilation grille may block the fan. Insufficient cooling of the inverter may result in output reduction or the failure of the system.

To provide protection against falling parts there is an optional accessory that covers the ventilation grilles but still allows cooling. To obtain one, please contact our service team.



WARNING

RISK OF BURNS FROM HOT PARTS IN THE INVERTER!

Some of the inverter components can reach temperatures of over 80°C during operation. Select the installation site in accordance with the information provided in these instructions. Always keep the ventilation openings clear.



Inverters can cause noise when in operation. Install inverter in such a way that people are not disturbed by operation noises.

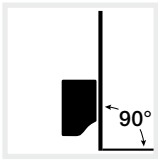

Mount inverters on vertical installation surfaces. To this purpose, use the provided wall mount.

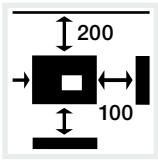

Maintain minimum distances to other inverters and the necessary clearance.

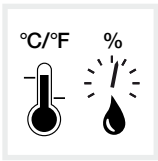

The ambient temperature must be between $-20\text{ }^{\circ}\text{C}$ and $+60\text{ }^{\circ}\text{C}$. The air humidity must lie between 4% and 100% (condensing).



Install inverters so that they are not accessible to children.

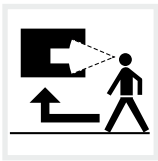

Inverters must be easily accessible and the display clearly visible.

Wall mounting **!!**

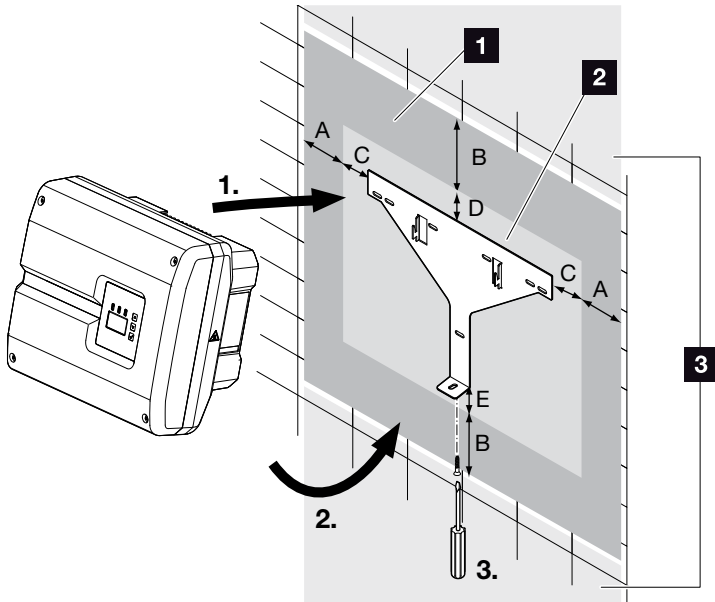

IMPORTANT INFORMATION

Be absolutely sure to maintain the clearance around the inverter in order that the inverter remains cool.



IMPORTANT INFORMATION

Only use the provided wall mount. When installing the wall mount, use all 5 retaining bolts.

Fig. 28: Wall mounting with wall mount

- 1** Clearance
- 2** Outer dimensions of the inverter
- 3** Inverters may not be installed in this area

You can find the distances for wall mounting in the following table:

Size	Dimensions in mm (inch)				
	A	B	C	D	E
PIKO 3.0, 4.2-8.5	100 (3.9)	200 (7.9)	60 (2.4)	70 (2.8)	2 (0.1)
PIKO 10-12	100 (3.9)	200 (7.9)	66 (2.6)	35 (1.4)	2 (0.1)
PIKO 15-20	100 (3.9)	200 (7.9)	76 (2.99)	46 (1.8)	2 (0.1)

Tab. 4: Distances for wall mounting

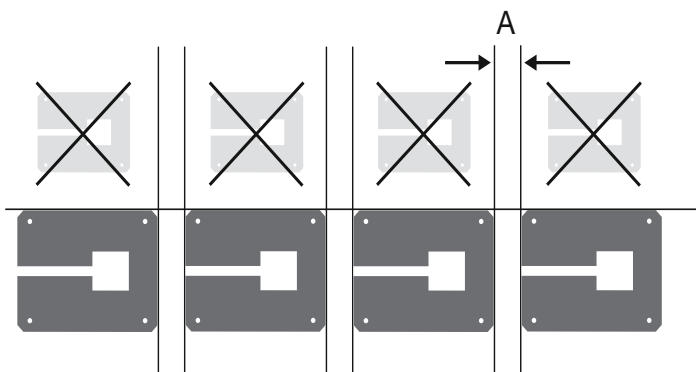

Fig. 29: Wall mounting of several inverters

3.4 Electrical connection

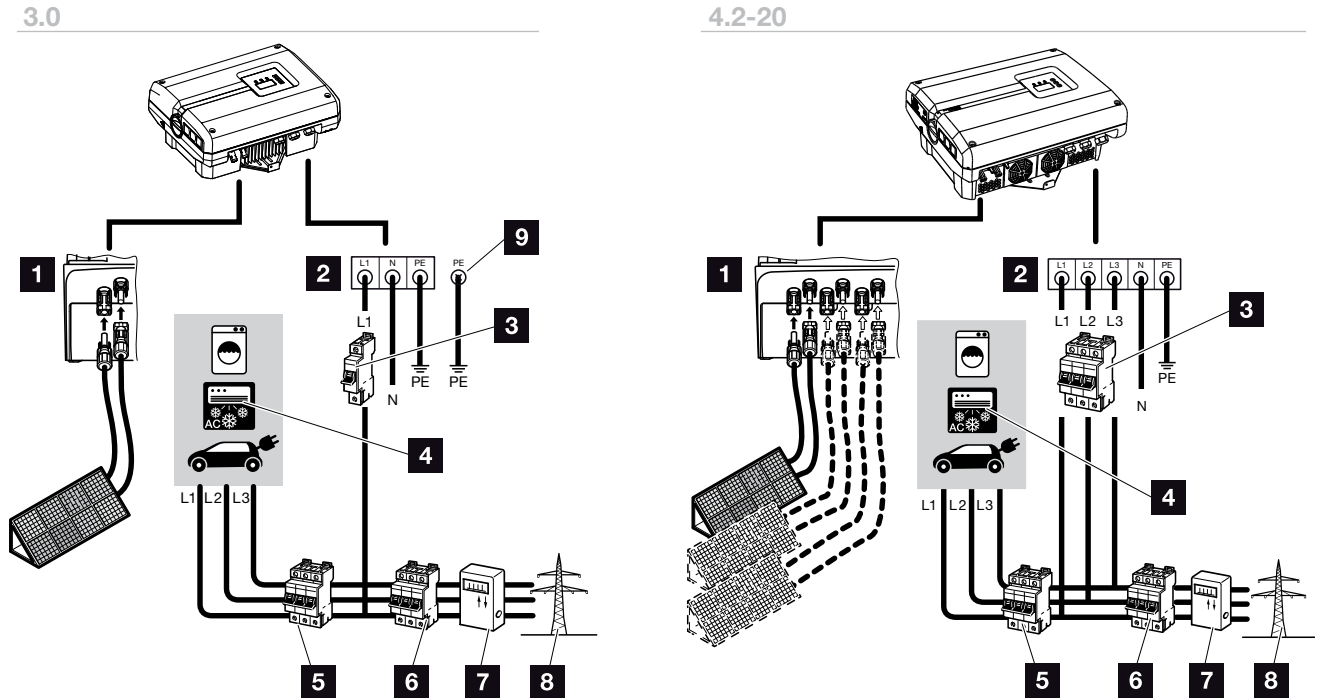

Fig. 30: Overview of the electrical connections with 1- and 3-phase inverters

Inverter connections

- 1 DC connections (dependent upon frame size)
- 2 AC terminal (1-phase or 3-phase) !

External connections !

- 3 Line circuit breaker for inverter (1-phase or 3-phase)
- 4 Energy consumers
- 5 Line circuit breaker for consumers
- 6 Line circuit breaker for house
- 7 Electricity meter
- 8 Public grid

Additional protective conductor terminal PIKO 3.0

- 9 Second protective conductor terminal (PE) of min. 2.5 mm² on inner or outer PE connection



IMPORTANT INFORMATION

It must be ensured that the phases of the AC terminal and the consumers are assigned uniformly.



IMPORTANT INFORMATION

This product may generate a direct current in the outer protective earthing conductor. If protective residual current devices (RCD) or residual current monitoring devices (RCM) are used, only type B RCDs or RCMs are permitted on the AC side. Refer to the manufacturer's declaration on our website for exceptions.

Connecting mains cable

1. De-energise the inverter.
🔧 **Ch. 4.3**
2. Switch off DC switch on the inverter.
🔧 **Fig. 16**
3. Secure it against reactivation.
4. Correctly lay the mains cable from the power distributor to the inverter. **⚠️ ⚠️**

3.0

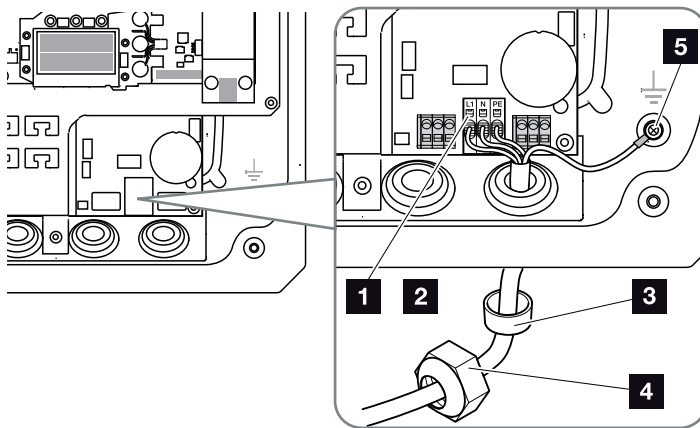

4.2 - 20

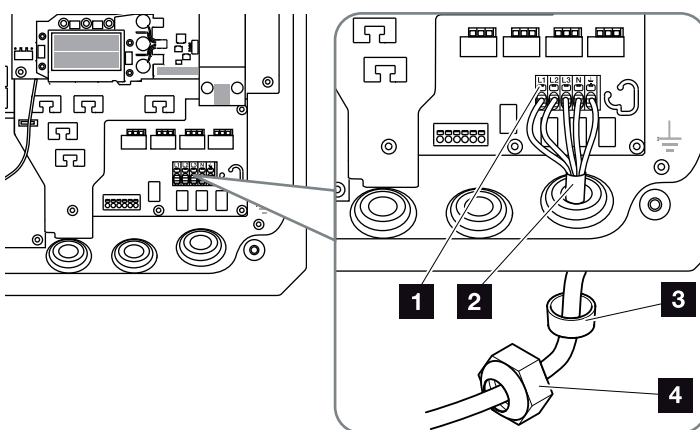

Fig. 31: Connect mains cable to the inverter

- 1** AC terminal
- 2** Mains cable
- 3** Sealing ring
- 4** Union nut
- 5** Additional protective conductor terminal for PIKO 3.0



IMPORTANT INFORMATION

See the chapter "Technical Data" for the dimensioning of the required AC line circuit breaker and the cable cross-sections to be used. 🔧 Ch. 10.1

If using an AC cable with an outer diameter of 15-23 mm, with PIKO 15-20, the reducing ring provided should be used.



IMPORTANT INFORMATION

For PIKO 3.0, there must always be a second protective conductor (PE) of min. 2.5 mm² connected on the inner or outer PE terminal with the screw provided.

5. Insert mains cable into the inverter and seal with sealing ring and union nut. Tighten union nut to the prescribed torque. Torques: 1.5 Nm (M12), 8 Nm (M25), 10 Nm (M32) and 13 Nm (M40). **!**
6. If screw connections are not being used, leave the blind plug in the screw connections.
7. Connect the wires of the mains cable to the AC terminal in accordance with the labelling. **!**

Fig. 31, It. 1

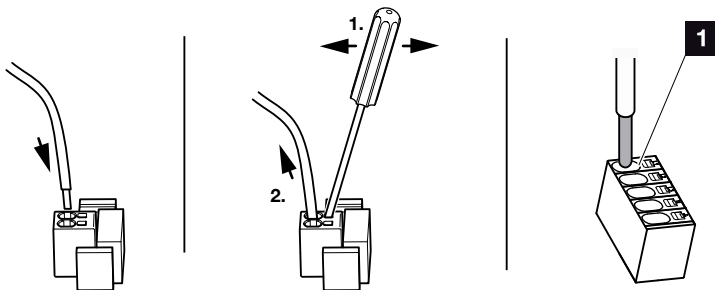

Fig. 32: Spring-loaded terminal strip

8. Install a line circuit breaker into the mains cable between the inverter and the feed meter to secure it against overcurrent. **!**
9. In countries in which a second PE connection is prescribed, connect this at the marked place on the housing (inside or outside) with the prescribed torque of 3 Nm (M6). **!** **Fig. 33, It. 1**

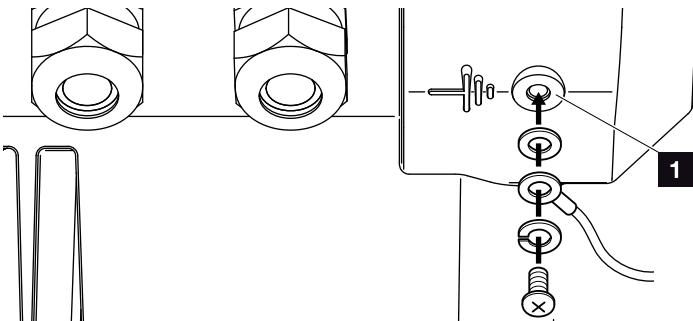

Fig. 33: Country-specific PE connection

✓ The AC connection is connected.



IMPORTANT INFORMATION

Existing cables and their routing within the inverter must not be changed. This can otherwise result in malfunctions in the inverter.



IMPORTANT INFORMATION

To connect the AC cables, the inverter is equipped with spring-loaded terminal strips. The wires should be inserted into the large round openings (It. 1) of the terminal. The wire stripping length is 15 mm.



WARNING

RISK OF FIRE DUE TO OVER-CURRENT AND HEATING OF THE MAINS CABLE!

Install line circuit breaker to secure against overcurrent.



IMPORTANT INFORMATION

The dimensioning of the cable cross-section to be used and the cable type must match the local requirements.

See "Technical data" chapter **Ch. 10.1**

3.5 Connection of solar module

Solar module connections

Note the following before connecting the DC plugs:

- Check for the correct planning and wiring of the modules and then measure the DC idling voltage for plausibility.
- In order to ensure an optimal layout of the solar modules and the highest possible yields, the system should be designed within the voltage range between V_{MPPmin} and V_{MPPmax} . PIKO Plan or KOSTAL Solar Plan should be used as a planning tool here.
- If the output of the solar modules is higher than that specified in the technical data, it must be ensured that the working point is still within the MPP voltage range of the inverter.
- If solar modules are used which have their own control systems for optimising the yield in every single module, the use of such solar modules should be set in the inverter's Webserver. A mixture of these and other solar modules is not permitted.
- Please ensure that the maximum permitted DC idling voltage is not exceeded.
Record and keep the measured values.
- Provide these measured values in the event of a complaint.

Failure to do so will make any manufacturer's warranty, guarantee or liability null and void unless you can prove that the damage was not due to non-compliance.



WARNING

RISK OF FIRE DUE TO IMPROPER INSTALLATION!

Incorrectly crimped plugs and sockets may heat up and cause a fire. During installation, be sure to follow the manufacturer's requirements and manual. Properly mount plugs and sockets.



WARNING

SERIOUS BURNS DUE TO ARCS ON THE DC SIDE!

DC cables must never be connected to or disconnected from the device during operation, as dangerous arcs may form. De-energise DC side, then mount or remove plug connector!



WARNING

INJURIES CAN RESULT FROM DESTRUCTION OF THE DEVICE!

When the maximum values for the permitted input voltage at the DC inputs are exceeded, this can result in serious damage, which may destroy the device and cause serious injury to any person present. Even briefly exceeding the voltage can cause damage to the device.

Parallel connection of solar module inputs

The function of the inverter operates based on the so-called string concept. In this system, a limited number of solar modules (depending on the desired power output while considering the maximum permissible input voltage) are connected in series as a string, which is then connected to the inverter.

The inverter is equipped with controllable inputs (DC1 and DC2) that can be connected in parallel. The device is accompanied by two bridges for this reason.

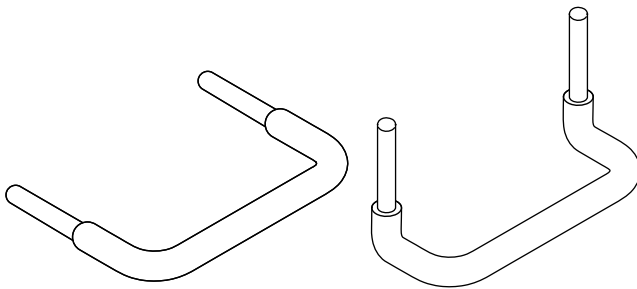

Fig. 34: Bridges for parallel connection



DAMAGE POSSIBLE

Excessive voltages on the DC side destroy the inverter.



DAMAGE POSSIBLE

One or two strings can be connected when the inputs DC1 and DC2 are connected in parallel. It must thereby be ensured that the entire input current for one or both inputs does not exceed the prescribed values. Input currents with parallel connection:  Ch. 10.1



IMPORTANT INFORMATION

Only the inputs DC1 and DC2 can be connected in parallel.



IMPORTANT INFORMATION

When more than 2 strings are connected in parallel, a string fuse may need to be installed. To this purpose, observe the information of the module manufacturer.

In the case of the PIKO 3.0 and 4.2, parallel connection of solar modules is not possible.

Connecting inputs in parallel:

1. De-energise the inverter. ⚠️
🔗 Ch. 4.3
2. Plug the provided bridges into the terminals as shown. ⚠️

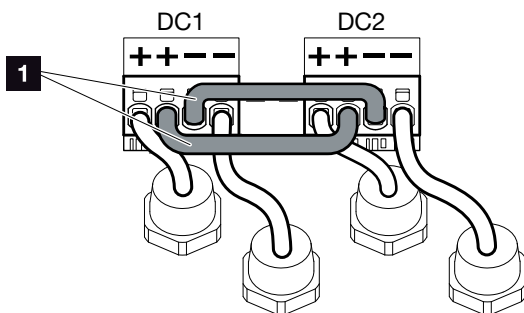

Fig. 35: Inputs 1 and 2 connected in parallel

- 1 DC bridges
3. Activate the parallel connection upon retrieval during initial commissioning. 🔗 Ch. 3.7
4. Leave the plug seals on the plug connectors not in use to protect them from moisture and dirt.
5. Install the cover and screw it tight (5 Nm).
- ✓ Parallel connection has been set up ⚠️.



DANGER

RISK OF DEATH DUE TO ELECTRICAL SHOCK AND DISCHARGE!

De-energise the device, secure it against being restarted and wait five minutes so that the capacitors can discharge. 🔗 Ch. 4.3



IMPORTANT INFORMATION

To connect the bridges, the inverter is equipped with spring-loaded terminal strips.



IMPORTANT INFORMATION

Parallel connection can still be changed in the Settings menu following initial installation.

🔗 Page 74

Connecting solar module ⚠️

Only solar modules of the following category may be connected: Class A as specified in IEC 61730.

1. The PV strings may only be connected to the inverter when the housing is closed.
2. De-energise the inverter. ⚠️
🔗 **Ch. 4.3**
3. If there is more than one inverter in a PV system, ensure that no cross-connection occurs when the PV generators are connected. 🏠

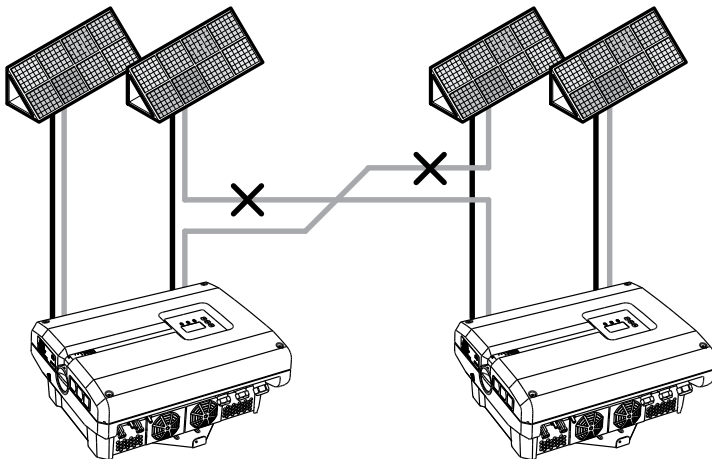

Fig. 36: Incorrect connection of PV generators

4. Check the strings for earth faults and short circuits and correct these where appropriate.



DANGER

RISK OF DEATH DUE TO ELECTRICAL SHOCK AND DISCHARGE!

The PV generators/cables may be live as soon as they are exposed to light.



DANGER

RISK OF DEATH DUE TO ELECTRICAL SHOCK AND DISCHARGE!

De-energise the device, secure it against being restarted and wait five minutes so that the capacitors can discharge. 🔗 Ch. 4.3



DAMAGE POSSIBLE

If the PV generators are incorrectly connected, the inverter may be damaged. Check the connections before commissioning.

5. Correctly mount the plug on the positive cable and the socket on the negative cable. During installation, always observe the latest specifications from the manufacturer (e.g. use of special tools, permissible tightening torques etc.).
When mounting the sockets and plugs on the DC cables used by the solar modules, ensure their polarity is correct! The poles of the PV strings (PV field) must not be earthed. **!** **i**
6. Plug the sockets and plugs of the DC cables onto the inverter. **Fig. 37**
Keep the plug seals from the plug connectors.

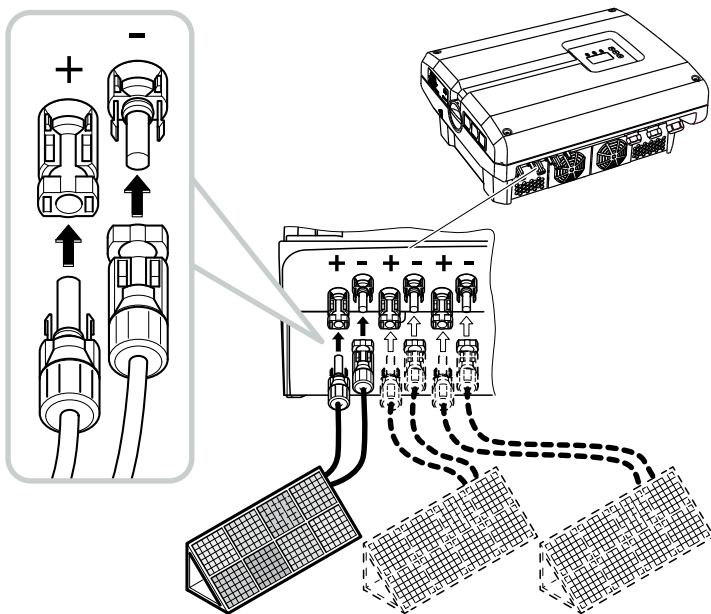

Fig. 37: Connect the PV string

- ✓ The DC side is connected.



IMPORTANT INFORMATION

The cross-section of the DC cables should be as large as possible, max. 4 mm² for flexible cables and 6 mm² for rigid cables. We recommend using tin-plated cables. If non-tin-plated cables are used, the copper strands may oxidise, as a result of which the transition resistance of the connections will be too high.



INFO

The PIKO 3.0-8.5 inverters are equipped with plug connectors from Multi-Contact (type MC4). More information about installation is available at www.multi-contact.com.

The PIKO 10-20 inverters are equipped with plug connectors from PHOENIX CONTACT (type SUNCLIX). More information about installation is available at www.phoenixcontact.com

3.6 Connection of communication components

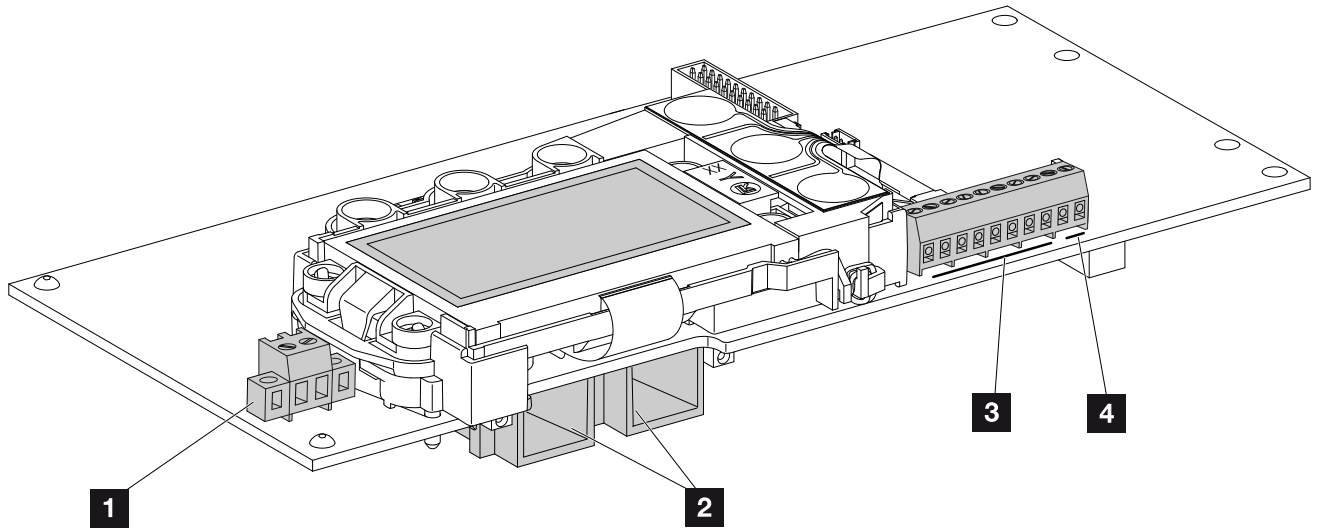

Fig. 38: Components of the communication board

- 1** Terminal S0/AL-Out (2-pin)
- 2** 2 Ethernet connections (RJ45)
- 3** Analogue interface terminal
- 4** Terminal for RS485 interface

The communication board is the communications centre of the inverter. The connections for communication, the display and the control buttons are found on the communication board.

The communication board is covered by a protective film over the S0/AL Out terminal. This can be lifted up for installation.

Terminal S0/AL-Out

The 2-pin S0/AL-Out terminal can be assigned various functions and configured via the Webserver under "Settings":

Switched output function: Pulse output

The switched output functions as a pulse output as described in EN 62053-31 with a constant rate of 2000 pulses per kilowatt hour. This function is a factory setting.

Switched output function: Alarm output

The switched output functions as a potential-free NC contact. It is opened when a fault occurs.

1. In the Webserver, go to "Settings" > "Switched output".
 2. In the "Switched output function" field, select the option "Alarm output".
 3. Click on "Accept".
- ✓ The "Alarm output" function is activated.

Switched output function: Self-consumption control or dynamic self-consumption control (switching of consumers)

The switched output functions as a potential-free NO switch. It closes when the set conditions are fulfilled.

1. In the Webserver, go to "Settings" > "Switched output".
 2. In the "Switched output function" field, select the option "Self-consumption control" or "Dynamic self-consumption control". 
 3. Click on "Accept".
- ✓ The "Self-consumption control" function is activated.



DAMAGE POSSIBLE

The terminal S0/AL-Out may only have a maximum load of 100 mA. The maximum permissible voltage is 250V (AC/DC).



INFO

When selecting "Dynamic self-consumption control", the measured home consumption determined with the PIKO BA Sensor available as an option is automatically added to the set value and taken into consideration.  **Ch. 8.3**

Terminal (10-pin)

The 10-pin terminal is arranged as follows.

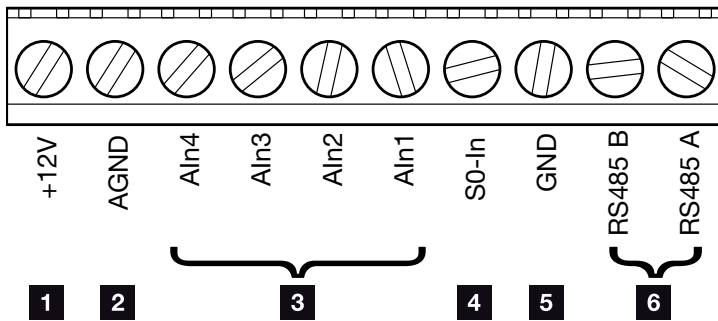

Fig. 39: Arrangement of the 10-pin terminal

Voltage output

- 1 **+12V:** 12 V output for external sensors or for ripple control receivers.

Analogue inputs

- 2 **AGND:** Ground for analogue inputs and S0 input
- 3 **Ain4-1:** Inputs for analogue sensors (0–10 V) or for ripple control receivers.

Pulse meter input

- 4 **S0-In:** The S0 input registers the pulses of an energy meter.

RS485 connections

- 5 **GND:** Ground for RS485
- 6 **RS485 connections A & B:** Serial RS485 interfaces for the connection of external data loggers, displays and additional inverters.



INFO

The voltage output is not potential-free. It can cope with a max. load of 100 mA.



INFO

Either a PIKO Sensor or a ripple control receiver can be connected to the analogue inputs Ain1 - Ain4.



INFO

When using the S0 input, the analogue inputs Ain3 and Ain4 are inactive.

A ripple control receiver can nonetheless be connected.

Connection options of the RJ45 sockets

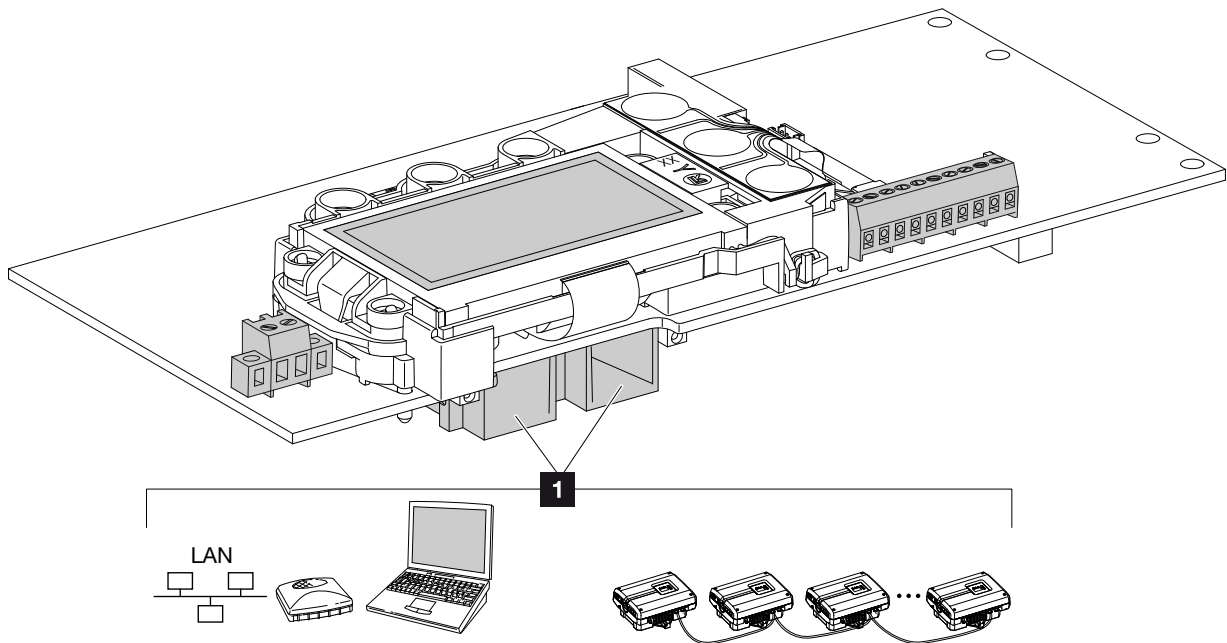

Fig. 40: Assignment of connection sockets

- 1 Socket RJ45:** computer, LAN, router, switch, hub and/or additional inverters.
For connection with a computer or with a computer network. **i** Connect several inverters to a network for data retrieval.



INFO

For connection with a computer or computer network (Ethernet 10BaseT, 10/100 MBit/s), an Ethernet cable of category 6 (Cat 6, FTP) with a max. length of 100m is to be used.

3.7 Initial commissioning

Procedure for initial commissioning

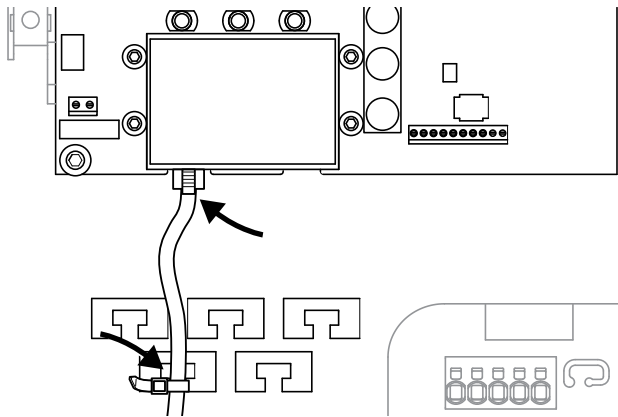





Fig. 41: Fasten the cable to the cable tray

1. Properly fasten all cables to the cable tray with a cable tie.  **Fig. 42**
 2. Tighten all cable screw connections and check that they are properly sealed.
 3. Check the fit of connected wires and braids.
 4. Remove any foreign objects (tools, wire cuttings, etc.) from the inverter.
 5. Install the cover and screw it tight (5 Nm). 
 6. Plug the sockets and plugs of the DC strings onto the inverter.  **Fig. 38**
 7. Activate grid voltage via the line circuit breaker.
 8. Switch the DC switch of the inverter to ON.  **Fig. 15**
If external DC voltage separators are present, activate the DC strings consecutively.
- The screensaver appears on the display and displays the device type.



IMPORTANT INFORMATION

At least the "Min. input voltage ($U_{DC_{min}}$)" must be present for initial commissioning. The output must be able to cover the inverter's self-consumption during initial commissioning.



IMPORTANT INFORMATION

If incorrectly assembled, the screws securing the cover may seize and destroy the thread inside the housing. Tighten the cover screws crosswise and do not fully tighten them immediately. This will make the cover more centred on the housing and prevent the screws inside the housing from seizing.

9. The screensaver is deactivated when any key is pressed twice. **i**

→ The "Language" menu appears on the display.

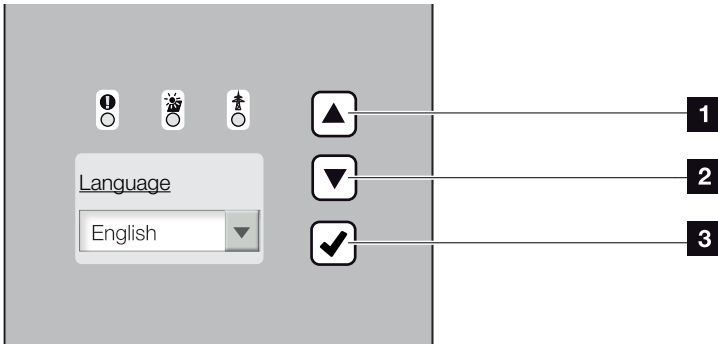

Fig. 42: Display on the inverter

1 "UP" arrow key

2 "DOWN" arrow key

3 "ENTER" key

10. Select language and confirm.

→ The "Date/Time" menu appears on the display.

11. Set date and time and confirm. **i**

→ The "String connection" menu appears on the display. **i**

12. Depending upon the wiring of the DC inputs, activate and confirm the parallel connection.

→ The "Current sensor position" menu appears on the display.

13. Select and confirm the desired mode with the arrow keys. **i**

→ The "Country setting" menu appears on the display.

14. Select and confirm the desired country/standard/directive.

→ A confirmation field for the "Country setting" appears on the display.



INFO

The installation process can vary depending upon the software version of the inverter.

Information on using the menu:

Ch. 4.4



INFO

The entry of date/time ensures that the downloaded log data has the correct time assigned to it.



INFO

The string connection retrieval only appears for inverters with at least 2 DC inputs.



INFO

Information on the various modes:

Ch. 11.1

15. In order to secure the country setting, select and confirm the confirmation field "Yes". 

✓ The settings are assumed by the inverter.

The inverter is in operation and can now be used. Initial commissioning is completed.



INFO

Once the country setting has been confirmed, it can only be changed by an installer or by entering the service code.

4. Operation and operating the device

4.1	Switching on the inverter	63
4.2	Switching off the inverter	64
4.3	De-energising the inverter	65
4.4	Control panel	66
4.5	Operational status (display)	69
4.6	Operational status (LEDs)	70
4.7	The menu structure of the inverter	71
4.8	The service menu	76
4.9	The energy management system in the inverter	77
4.10	Event codes	78

4.1 Switching on the inverter

1. Activate grid voltage via the line circuit breaker.
2. Switch the DC switch on the inverter to ON.

Fig. 15

If external DC voltage separators are present, activate the DC strings consecutively.

- The inverter starts up.
- During start-up, the three LEDs in the control panel of the inverter will light up briefly. The inverter can now be operated.
- The screensaver appears on the display and displays the device type. The screensaver is deactivated when a key is pressed twice. 
- ✓ The inverter is in operation.



INFO

When no key has been pressed for several minutes, the screensaver with the image of the inverter appears automatically on the display.

4.2 Switching off the inverter



In order to switch off the inverter, carry out the following steps. Additional steps are necessary for maintenance or repair work on the inverter.  **Ch. 4.3.**

1. Turn the DC switch on the inverter to OFF.  **Fig. 16**
2. If external DC voltage separators are present, switch off the DC strings consecutively.

4.3 De-energising the inverter

When working on the inverter or the feed cables, the inverter must be completely de-energised. ⚠

It is imperative that these steps are carried out:

1. Turn the DC switch on the inverter to OFF.  **Fig. 16**
2. Switch off the AC line circuit breaker.
3. Switch off the power supply for the S0/AL-Out output (if present).
4. Secure the entire voltage supply against being restarted.
5. Disconnect all DC connections on the inverter. 

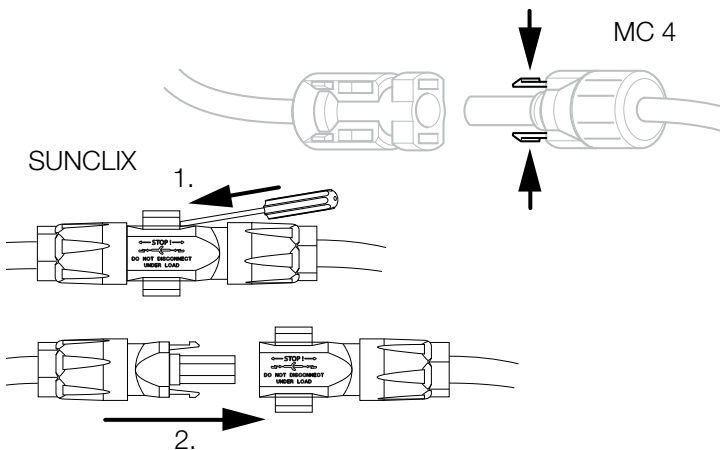

Fig. 43: Press together the engaging clips

6. Wait five minutes until the capacitors of the inverter have discharged. Allow the device to cool down.
 7. Ensure that all connections are voltage-free.
- ✓ The inverter is de-energised. Work on the inverter or on the feed cables can now be carried out.



DANGER

RISK OF DEATH DUE TO ELECTRICAL SHOCK AND DISCHARGE!

De-energise the device, secure it against being restarted and wait five minutes so that the capacitors can discharge.



IMPORTANT INFORMATION

With MC-4 plugs: Use the disassembly tool of the plug manufacturer. Press the engaging clips together and pull off the plug.

With SUNCLIX plugs: Unlock the engaging clips with a screwdriver and disconnect the plug.

4.4 Control panel

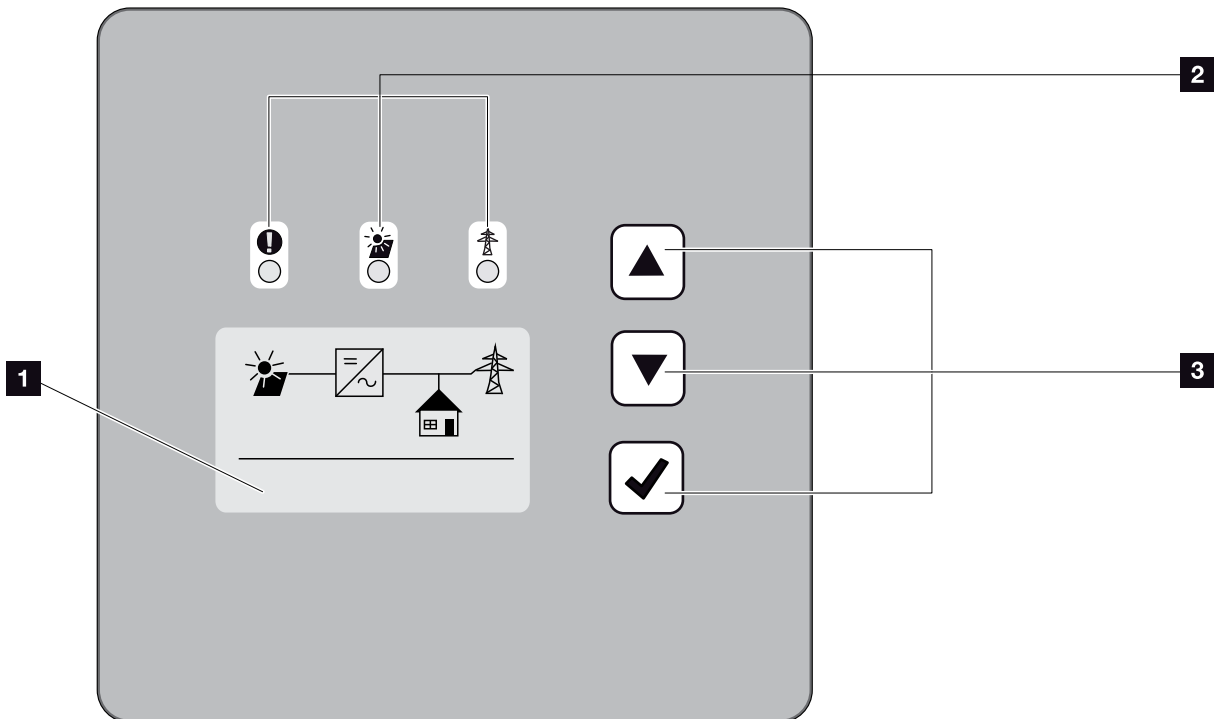

Fig. 44: Control panel

- 1** Display (display dependent upon the inverter type.
Here it is the menu of the 3-phase inverter)
- 2** "Fault" LED (red)
"DC" LED (yellow)
"AC" LED (green)
- 3** Arrow key "UP"
Arrow key "DOWN"
Key "ENTER"

The inverter indicates the respective operational status through three LEDs and the display. **i**

The operating values can be retrieved and settings adjusted on the display.



INFO

When no key has been pressed for several minutes, the screensaver with the image of the inverter appears automatically on the display.

Operation of the display

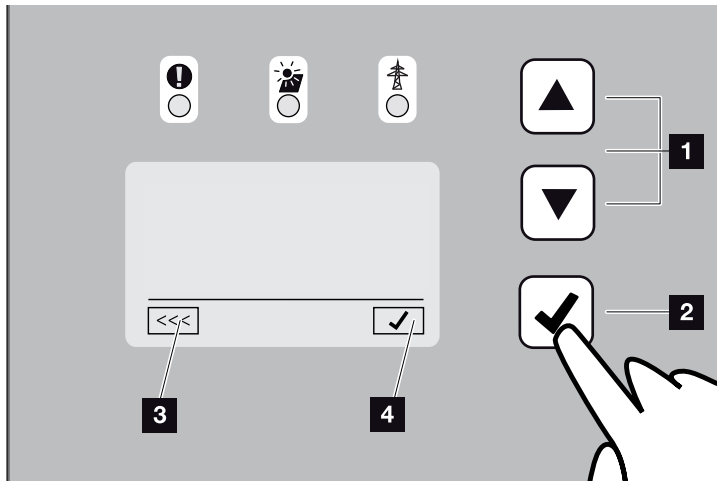

Fig. 45: Operation of the display

- 1 UP/DOWN:** Characters, buttons and input fields are selected with the arrow keys.
- 2 ENTER: Briefly pressing** the "ENTER" key activates the selected menu element or confirms the entry at the end.
Pressing "ENTER" for an **extended time** confirms the entry.
- 3 Back:** This function can be used to jump to the higher level menu. Values entered in the menu must be saved in advance, as these will not otherwise be adopted.
- 4 Confirm:** Values are adopted or the selected function confirmed with this function.

Entry of text and numbers

The display can also be used to enter texts and numbers (e.g. inverter name and portal code). The table below explains the functions for the entry of text and numbers.



Object with a dashed line means: Object is selected and can be activated with "ENTER".



Object with black background:
Object is active and can be edited.



Character with a black background means:
Character is selected and can be changed with the arrow keys.



Characters in text fields are deleted with this function. To this end, go to after the last character and press an arrow key (the character << appears in the text field). The characters can now be deleted by pressing the "ENTER" key.

4.5 Operational status (display)

The operational statuses are shown on the display of the inverter.

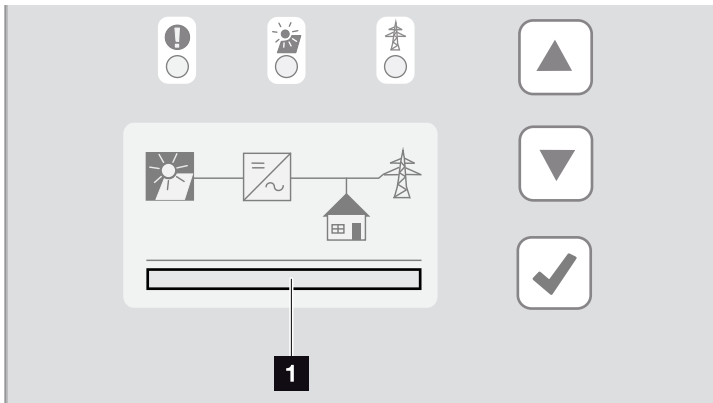



Fig. 46: "Operational status" display area

1 Display area showing the operational statuses

The following table explains the operational notifications that can appear on the display:

Display	Explanation
Off	Input voltage on the DC side (photovoltaic modules) is too low
Standby	Electronics are ready for operation, DC voltage or DC power is still too low for feed-in
Starting	Internal control measurements according to VDE 0126
Feed-in (MPP)	Measurement successful, MPP control active (MPP = maximum power point)
Feed-in regulated	Feed-in is regulated on the basis of a fault (e.g. PV energy is limited  Ch. 7, excess temperature, fault)
Event code xxxx	An event is present. Remedial measures can be found in the "Event codes" chapter  Ch. 4.10

Tab. 5: Operational notifications on the display of the inverter

4.6 Operational status (LEDs)

The LEDs on the front of the device indicate the current operational status.

LEDs on the inverter

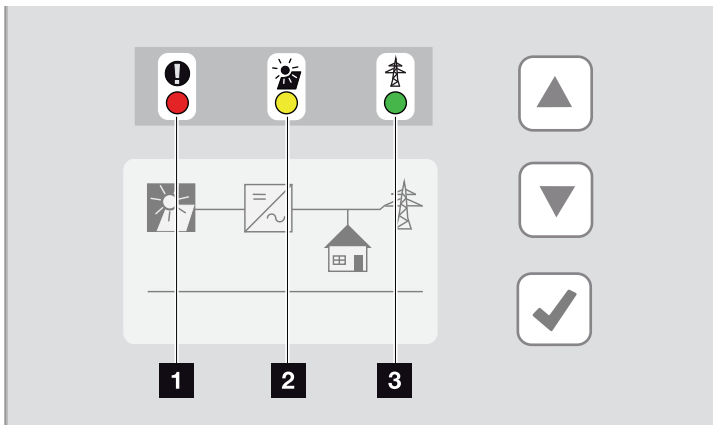

Fig. 47: LEDs on the display of the inverter

1 "Fault" LED flashes or lights up red:

A fault has occurred. Remedial measures can be found in the "Event codes" chapter [Ch. 4.10](#)

2 "DC" LED lit yellow: The yellow LED signals the active status of the inverter control unit. It lights up as soon as the minimum input voltage (V_{DCmin}) is present at one of the DC inputs but the inverter is not yet feeding.

"DC" LED flashes yellow: A fault has occurred. Remedial measures can be found in the "Event codes" chapter [Ch. 4.10](#)

3 "AC" LED lit green: The green LED signalises feed-in operation of the inverter.

No LED is lit: The device is ready for operation, but the input voltage is too low [Ch. 10.1](#).

OR: The device is switched off.

4.7 The menu structure of the inverter

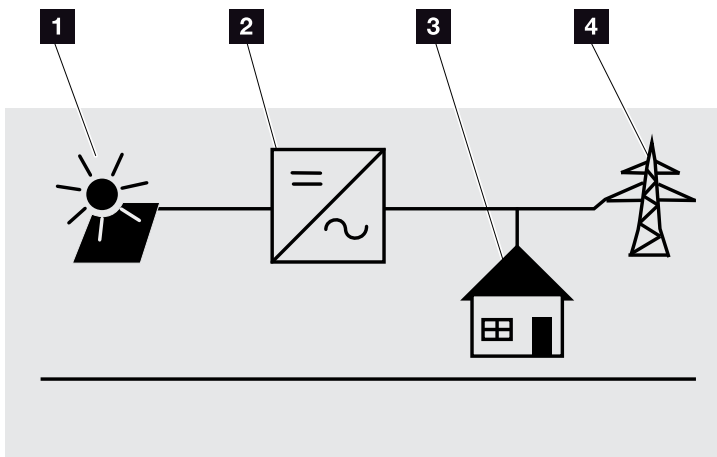

Fig. 48: Main menu structure on the display

- 1 DC menu
- 2 Settings menu
- 3 Self-consumption menu
- 4 AC menu

The menus* are listed individually on the following pages.

*Deviations due to software versions (UI status) possible.

DC menu



- DC input 1 (U,I,P)
- DC input 2 (U,I,P)¹
- DC input 3 (U,I,P)¹

AC menu



- Phase 1 (U,I,P)
- Phase 2 (U,I,P)²
- Phase 3 (U,I,P)²
- Total yield ————— Yield (Wh)
- Operation time (h)
- Grid parameter ————— Limitation on (%)
- Grid frequency [Hz]
- cos φ
- Daily yield (diagram)
- Monthly yield (diagram)
- Annual yield (diagram)
- Total yield (diagram)–

¹ DC inputs depending on device type

² phases depending on device type

Self-consumption menu¹

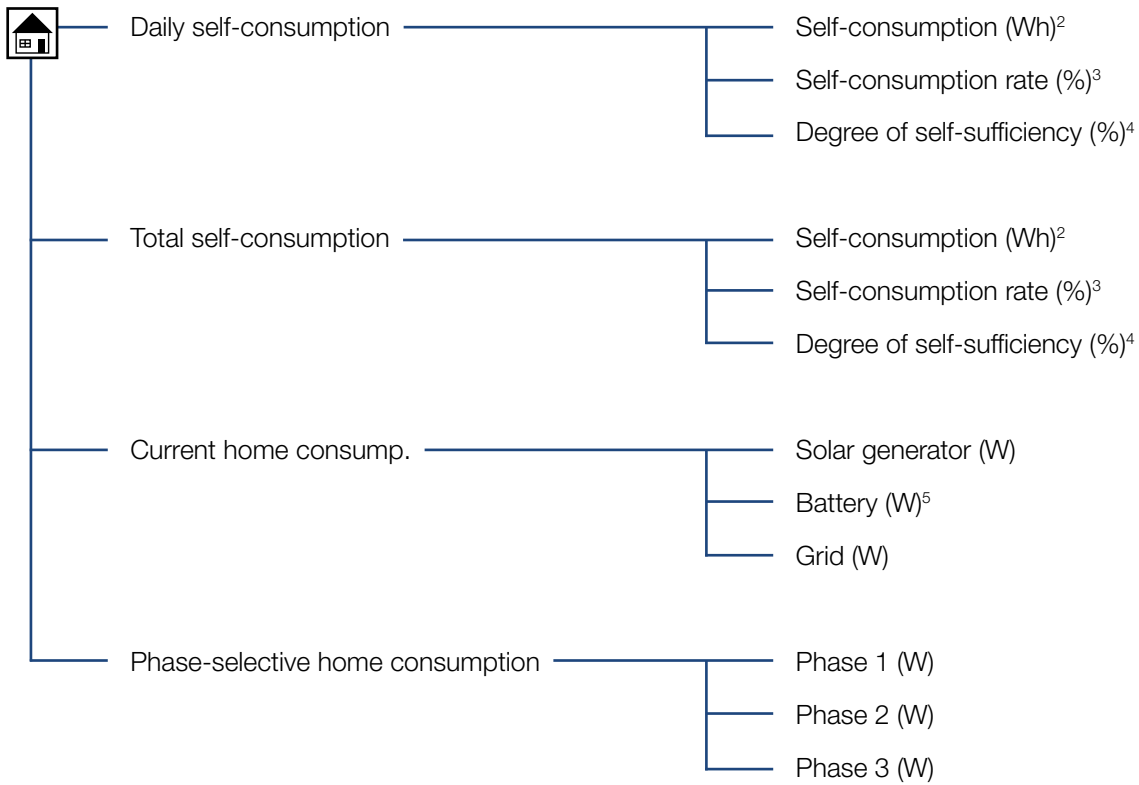

¹ The self-consumption functions can only be used/displayed in connection with a PIKO BA Sensor.

² Self-consumption: Shows the power generated by the inverter that has been used up to this point in time in the building itself.

³ Self-consumption rate: Shows the self-consumption in relation to the total power generated by the inverter. States the percentage of generated PV power used for self-consumption.

⁴ Degree of self-sufficiency: Shows self-consumption in relation to home consumption. States the percentage of energy consumed in the building that is covered by PV energy.

⁵ Values are only shown in the battery inverter.

Settings menu

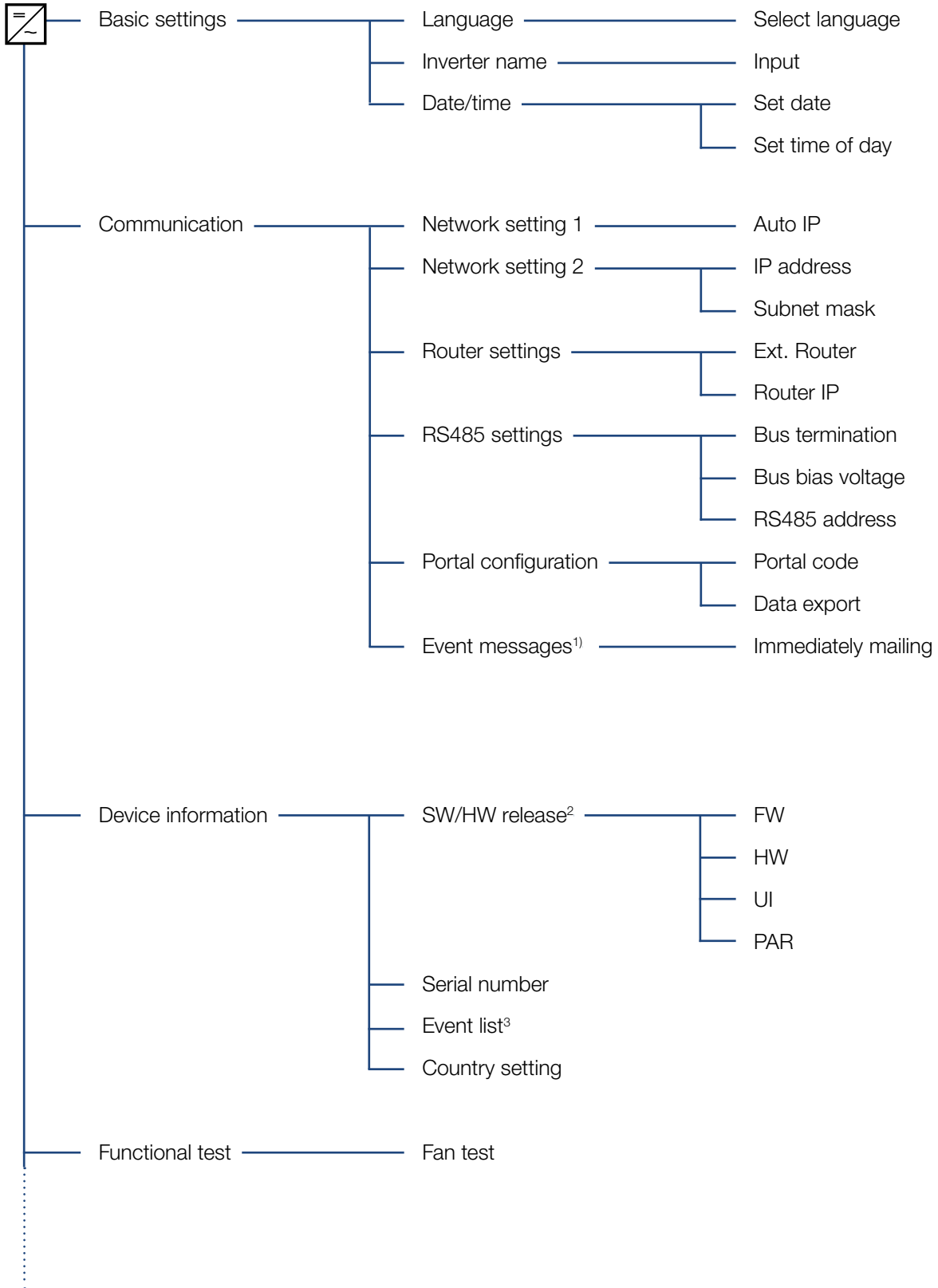

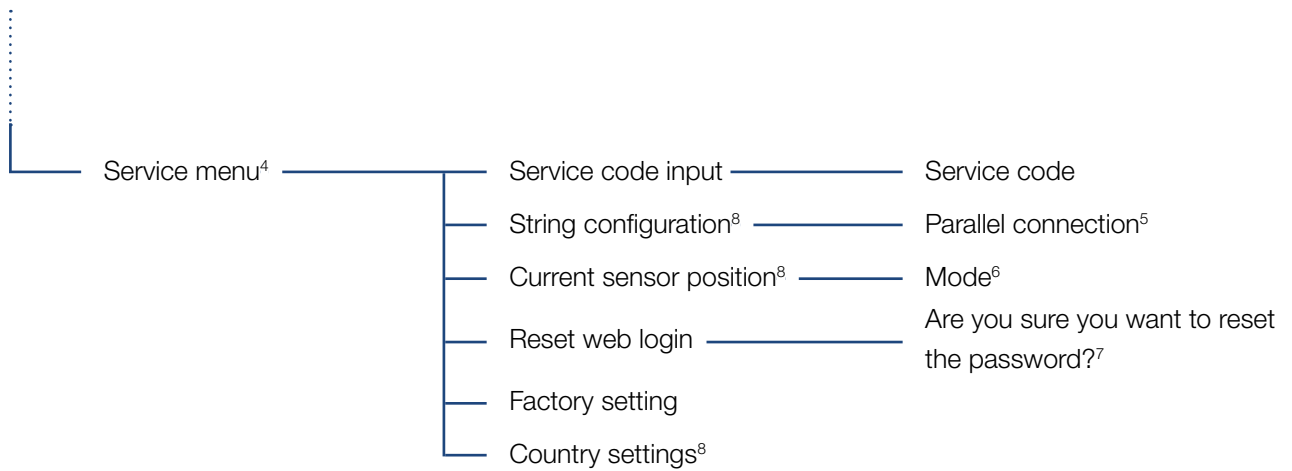

¹ Event messages can be faults or other events. The "Immediately mailing" option sends the event message immediately following the data capture period to a selected Internet portal.

² SW/HW release, FW: Firmware release, HW: Hardware release, UI: Software release of the communication board, PAR: Version of the parameter file

³ A maximum of 10 events are displayed. Information about events can be found in the "Event codes" chapter.

⁴ Following entry of a code, additional menu items for configuring the inverter appear. The code can be requested for installers from the Service team.

⁵ The parallel connection menu item is only visible for inverters with at least 2 DC inputs.

⁶ The inverter carries out a restart when the position (mode) of the current sensor is changed in the menu.

⁷ The Webserver password for the "pvserver" user is reset to the default values "pvwr" .

⁸ Only visible once the service code has been entered.

4.8 The service menu



Using the inverter's service menu, the installer can perform settings on the inverter, which are not available to the normal user.

For the service menu and other service settings that only an installer can make to be displayed in the communication board, the installer must request a code via the inverter manufacturer's service.

The code is entered by going to the following menu item: Settings > Service menu > Service code

Once the service code has been entered and confirmed, the additional service menu entries appear. 

Below you will find a description of the additional functions and settings available:

Service menu entry	Description
Service code	Input of service code and enabling of additional menu items.
Reset web login (possible without service code)	Reset Webserver login to default values. Default values for Webserver login: User " pvserver " Password " pvwr "
Factory setting (possible without service code)	Reset inverter to factory setting. All settings are deleted apart from the country setting.
Country setting	Reset the country setting. Once the reset is complete, the inverter reports back with the country setting.
String configuration	Parallel connection:  Parallel connection can be activated or deactivated here depending on the connection of DC inputs DC1 and DC2 in the inverter. A detailed description of parallel connection can be found in the chapter  Ch. 3.5
Current sensor position	Mode: Set the mode of the optional current sensor PIKO BA Sensor.  Ch. 11.1



INFO

The service menu entries depend on the installed inverter firmware (FW) and the communication board software (UI) and may deviate from the description provided here.



INFO

A parallel connection is only possible for inverters with at least 2 DC inputs.

4.9 The energy management system in the inverter

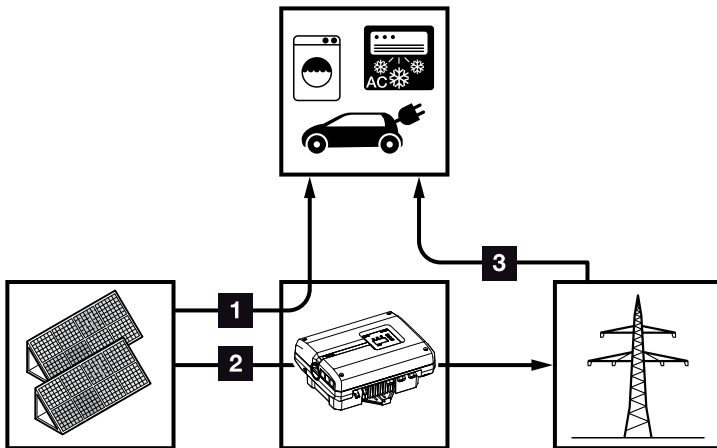

Fig. 49: Control and distribution of the energy flows

- 1 PV energy:** Consumption via local consumers
- 2 PV energy:** Feed-in to the public grid
- 3 Grid energy:** Consumption via local consumers

The energy management system (EMS) controls the distribution of the energy between the DC side (solar generator) and the AC side (building grid, public grid). To this purpose, the EMS uses the PIKO BA Sensor to check for the presence of consumption in the internal home network. The logic of the EMS then calculates and controls the optimal usage of PV energy.

The generated PV energy is primarily used for consumers (such as light, washing machine or television). The remaining generated PV energy is fed into the grid and remunerated.

4.10 Event codes

There is no need to take action when an event occurs occasionally or only briefly and the device resumes operation. When an event occurs over long periods or recurs frequently, the cause must be determined and rectified. ⚠

In case of a permanent event, the inverter interrupts the feed-in and switches off automatically.

- Check whether the DC switch or the external DC voltage separator has been switched off.
- Check whether the event is due to a mains power failure or whether the fuse between the feed meter and the inverter has tripped.

If the fuse has tripped, notify the installer; if there is a power failure, simply wait until the grid operator has corrected the problem.

If the event lasts only a short time (grid fault, overheating, overload, etc.), then the inverter will automatically resume operation as soon as the event has been resolved.

If the event persists, notify your installer or the manufacturer's customer support team. ⓘ

Provide the following information:

- Device type and serial number. You will find this information on the type plate on the exterior of the housing.
- Description of fault (LED display and display message).

The type of event can be determined on the basis of the message in the display "Event code: xxxx" and the following table.

In the case of events not listed in the table, please contact Service.



DANGER

RISK OF DEATH DUE TO ELECTRICAL SHOCK AND DISCHARGE!

Life-threatening voltages are present in the inverter. Only a qualified electrician may open and perform work on the device.



















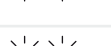
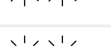
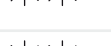
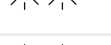

INFO

You can find contact details in the chapter "Warranty and service":























📄 **Ch. 12.2**

Event code	LED display	Type of event	Description/ possible cause	Measure
3000		Update process fault	Internal system fault	Perform inverter update.
3003		Internal communication fault	Internal communication fault between grid monitoring and control system	Check the internal communication cables between the individual PCBs ¹
3006		Internal system fault	Internal system fault with respect to power curtailment	Device carries out a test several times and generally overrides. Support ¹
3010		Internal communication fault	Internal communication fault between control system and communications PCB	Check the time setting, function of the communications PCB and other communication settings. Inverter switches despite incorrect time stamp ¹
3011		Internal temperature fault	Internal system fault	Support ¹
3012		Varistor fault	DC varistor defective	Replace defective varistor ¹
3013		Internal temperature fault	Excess temperature AC/DC at power level	Check installation conditions and fan ¹
3014		Internal temperature fault	Overheating of processor	Check installation conditions and fan ¹
3017		External generator fault	Overvoltage on PV generator	Check generator installation/configuration ¹
3018		Information	Power curtailment through external specifications (grid operator)	No action necessary.
3019		External grid fault	Power curtailment due to a grid fault (increased grid frequency)	Support ¹
3020		External generator fault	Overcurrent on the PV generator	Check generator installation/configuration ¹
3021		Internal system fault	Internal system fault	Support ¹
3022		External generator fault	Overvoltage on PV generator	Check generator installation/configuration ¹
3023		External generator fault	Overcurrent on the PV generator	Check generator installation/configuration ¹
3024		Internal system fault	Internal system fault	Support ¹
3025		External generator fault	Overvoltage on PV generator	Check generator installation/configuration ¹
3026		External generator fault	Overcurrent on the PV generator	Check generator installation/configuration ¹
3027		Internal temperature fault	Internal system fault	Support ¹
3028		External generator fault	Overvoltage on PV generator	Check generator installation/configuration











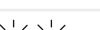

Event code	LED display	Type of event	Description/ possible cause	Measure
3029		External generator fault	Overcurrent on the PV generator	Check generator installation/ configuration ¹
3030		Internal temperature fault	Excess temperature AC/DC at power level	Check installation conditions and fan ¹
3031		Internal system fault	Internal AC system fault	Device carries out test several times and generally overrides ¹
3032		External generator fault	Overcurrent on the PV generator	Check generator installation/ configuration ¹
3033		Internal system fault	Internal system fault	Support ¹
3034		Internal system fault	Internal intermediate circuit fault	Restart the device ¹
3035		Internal system fault	Internal intermediate circuit fault	Restart the device ¹
3036		Internal system fault	Internal system fault	Contact support
3037		Internal system fault	Internal system fault	Contact support
3038		Internal system fault	Internal system fault	Contact support
3039		Internal parameterization fault	Internal system fault	Contact support
3045		Internal system fault	Internal AC system fault	Device carries out test several times and generally overrides ¹
3046		Internal system fault	Internal AC system fault	Device carries out a test several times and generally overrides. ¹
3047		Internal system fault	Internal system fault	Support ¹
3048		Internal communication fault	Internal communication error	Check the internal communication cables between the individual PCBs ¹
3049		Internal communication fault	Internal communication error	Check the internal communication cables between the individual PCBs ¹
3050		Internal communication fault	Internal communication error	Check the internal communication cables between the individual PCBs ¹
3051		Internal system fault	Internal system fault	Support ¹
3052		Internal system fault	Internal system fault	Support ¹
3053		Internal system fault	Internal system fault	Support ¹
3054		Internal system fault	Internal system fault	Support ¹

Event code	LED display	Type of event	Description/ possible cause	Measure
3055		Internal system fault	Internal system fault	Restart the device ¹
3056		Internal parameterization fault	Internal system fault	Contact support
3057		Internal system fault	Internal system fault	Check generator installation/ configuration ¹
3059		Internal parameterization fault	Incorrect parameterization	Country setting may be incorrect. Contact support
3060		Internal parameterization fault	Incorrect parameterization	Contact support
3061		Internal system fault	Internal system fault	No action necessary ¹
3062		Internal temperature fault	Internal system fault	No action necessary ¹
3063		Internal parameterization fault	Internal system fault	Contact support
3064		Internal system fault	Internal system fault	No action necessary ¹
3065		Internal system fault	Internal system fault	No action necessary ¹
3066		Internal parameterization fault	Internal system fault	Contact support
3068		Internal system fault	Internal system fault	Restart the device ¹
3070		Internal system fault	Internal AC system fault	Device carries out a test several times and generally overrides ¹
3071		Internal system fault	Internal AC system fault	Device carries out a test several times and generally overrides ¹
3072		Internal system fault	Internal AC system fault	Device carries out a test several times and generally overrides ¹
3073		Internal system fault	Internal AC system fault	Device carries out a test several times and generally overrides ¹
3074		Internal system fault	Internal AC system fault	Device carries out a test several times and generally overrides ¹
3075		Internal system fault	Internal AC system fault	Device carries out a test several times and generally overrides ¹
3076		Internal system fault	Internal AC system fault	The AC voltage may be too low.
3079		Internal system fault	Internal system fault	Restart the device ¹
3080		Internal system fault	Internal system fault	Restart the device ¹
3082		Internal system fault	Internal system fault	Contact support

Event code	LED display	Type of event	Description/ possible cause	Measure
3083	○ ○ ○	Information	Internal system fault	No action necessary ¹
3084	☀ ☀ ○	Internal system fault	Internal system fault	Contact support
3085	○ ○ ☀	Internal temperature fault	Overheating of processor	Check installation conditions and fan ¹
3086	○ ☀ ☀	Information	Power curtailment due to a grid fault (increased AC voltage)	Support ¹
3087	○ ☀ ☀	Internal system fault	Internal system error	Contact support
3088	○ ☀ ☀	Internal system fault	Fan unit dirty	Clean fan unit
3089	○ ☀ ☀	Internal system fault	Fan unit dirty	Clean fan unit
3090	○ ☀ ☀	Internal system fault	Internal system error	Contact support
3091	○ ☀ ☀	Internal system fault	Fan not correctly connected	Check fan plug connections
3092	○ ☀ ☀	Internal system fault	Fan not correctly connected	Check fan plug connections
3093	☀ ☀ ○	Internal parameterization fault	Incorrect parameterization	Contact support
3094	☀ ☀ ○	Internal parameterization fault	Incorrect parameterization	Contact support
3095	☀ ☀ ○	Internal parameterization fault	Incorrect calibration	Contact support
3096	○ ○ ○	Information	PV generator does not have optimum design	Check generator installation/ configuration
3097	☀ ☀ ○	Internal parameterization fault	Incorrect parameterization	Contact support
3098	○ ○ ○	Information	Grid functionality not available	No action necessary ¹
3101	○ ○ ○	Information	Internal system fault	No action necessary ¹
3102	☀ ☀ ○	Internal system fault	Internal system fault	No action necessary ¹
3103	☀ ☀ ○	Internal system fault	Internal system fault	No action necessary ¹
3104	☀ ☀ ○	Internal system fault	Internal AC system fault	Device carries out a test several times and generally overrides ¹
3105	☀ ☀ ○	Internal system fault	Internal system fault	No action necessary ¹
3106	○ ○ ○	Information	Incorrect input on communication board or incorrect wiring	Correct input or wiring ¹

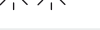
Event code	LED display	Type of event	Description/ possible cause	Measure
4100		Internal system fault	Internal software error	Support ¹
4101		Internal system fault	Increased DC current L1	Support ¹
4102		Internal system fault	Increased DC current L2	Support ¹
4103		Internal system fault	Increased DC current L3	Support ¹
4104		Internal system fault	Increased DC current L1	Support ¹
4105		Internal system fault	Increased DC current L2	Support ¹
4106		Internal system fault	Increased DC current L3	Support ¹
4110		Internal system fault	Internal software error	Support ¹
4121		Internal system fault	Internal system fault	Support ¹
4122		Internal system fault	Internal system fault	Support ¹
4130		Internal system fault	Internal system fault	Support ¹
4131		Internal system fault	Internal system fault	Support ¹
4150		Information	Increased grid frequency. Frequent recurrence in the morning and the evening.	Check the installation ¹
4151		External grid fault	Grid frequency too low	Check the installation ¹
4157		External grid fault	Increased grid frequency	No action necessary ¹
4158		External grid fault	Increased grid frequency	Check the installation ¹
4159		External grid fault	Increased grid frequency	Check the installation ¹
4160		External grid fault	Increased grid frequency	Check the installation ¹
4161		External grid fault	Grid frequency too low	Check the installation ¹
4170		Information	One phase is not connected. A miniature circuit breaker was not switched on.	Check the installation ¹
4180		External grid fault	PE cable not connected	Check the installation ¹
4181		External grid fault	PE cable not connected	Check the installation ¹



Event code	LED display	Type of event	Description/ possible cause	Measure
4185		Internal system fault	Internal software error	Support ¹
4200		External grid fault	Increased grid voltage	Check the installation ¹
4201		External grid fault	Grid voltage too low	Check the installation ¹
4210		External grid fault	Increased grid voltage	Check the installation ¹
4211		External grid fault	Grid voltage too low	Check the installation ¹
4220		External grid fault	Voltage mean value of the last 10 minutes too high	Check the installation ¹
4221		External grid fault	Voltage mean value of the last 10 minutes too high	Check the installation ¹
4290		External grid fault	The grid frequency has changed too quickly.	Check generator installation ¹
4300		Internal system fault	Internal system fault	Support ¹
4301		Internal system fault	Internal system fault	Support ¹
4302		Internal system fault	Internal system fault	Support ¹
4303		Internal system fault	Internal system fault	Support ¹
4304		Internal system fault	Internal system fault	Support ¹
4321		Internal parameterization fault	Defective EEPROM, forbidden memory access	Support ¹
4322		Internal parameterization fault	Software error	Contact support
4323		Internal parameterization fault	Residual current	Support ¹
4324		Internal parameterization fault	Parameter error	Support ¹
4325		Internal parameterization fault	Parameter error	Support ¹
4340 - 4354		External residual current	Residual current	Check generator installation ¹
4360 - 4421		Internal system fault	Internal system fault	Support ¹
4422		Internal system fault	Internal system fault	Contact support.
4424		Internal system fault	Internal system fault	Support ¹
4425		Internal parameterization fault	Parameter error	Support ¹

Event code	LED display	Type of event	Description/ possible cause	Measure
4450		External insulation fault	Insulation fault	Check generator installation ¹
4451		Internal system fault	Internal system fault	Contact support
4475		Internal system fault	Internal system fault	Support ¹
4476		Information	Weak PV supply (e.g. in the morning)	No action necessary ¹
4800		Internal system fault	Internal system fault	Support ¹
4801		Internal system fault	Insulation fault	Support ¹
4802		Internal system fault	Internal system fault	Support ¹
4803		Internal system fault	Insulation fault	Support ¹
4804		Internal system fault	Insulation fault	Support ¹
4805		Internal system fault	Internal system fault	Support ¹
4810		Internal system fault	Internal system fault	Support ¹
4850		Internal system fault	Energy supply company	Support ¹
4870 - 7500		Internal system fault	Internal system fault	Support ¹
7503		Information	Internal system fault	No action necessary ¹

Tab. 6: Event codes

¹ If the error occurs several times/permanently, please contact Support.

Legend for the "Event codes" table

-  LEDs flashing
-  LEDs lit up
-  LEDs off

5. Webserver

5.1	The Webserver	87
5.2	Using the Webserver	88
5.3	Connecting the inverter and computer	89
5.4	Menu structure in web browser	91
5.5	Webserver main menu	93
5.6	Webserver submenus	94

5.1 The Webserver

The Webserver forms the graphic interface (shown in the browser) between the inverter and the user.*

*Deviations due to software versions (UI status) possible.



Fig. 50: Webserver

- 1** Selection of language
- 2** Logged-in user
- 3** Inverter name
- 4** Menu
- 5** Values/input boxes
- 6** "Reset" button clears the input and resets it to the previous value.
- 7** "Accept" button saves and accepts all changes

The Webserver* allows the user to view important information, current values, events and versions (e.g. user interface, firmware or hardware) relating to the inverter. The statistics provide a summary of the yield and operating duration and also provide the log data, which supplies other information. The inverter can also be quickly and easily configured in the Settings.

5.2 Using the Webserver

The Webserver is accessed on the inverter from a computer using a web browser (e.g. Internet Explorer). Both devices must be on the same network. 

Settings in the computer¹

- In the Internet protocol (TCP/IP) of the computer, the options "Automatically acquire IP address" and "Automatically acquire DNS server address" must be activated. 

You can go to the settings for the Internet protocol (TCP/IP) via the control panel:

Control Panel >> Network and Sharing Center >> Change Adapter Settings.

Right-click on the LAN connection >> Properties >> Select "Internet protocol (TCP/IPv4)" > Properties.

- In the LAN settings of the computer, the option "Use proxy server for LAN" must be deactivated.

You can reach the "LAN settings" via the control panel: Control Panel >> Internet options >> Tab: "Connections" >> LAN settings.



TIP

Any device (e.g. a tablet PC) that has a browser (e.g. Internet Explorer 11 or Firefox 50), can be used to access the Webserver.

¹ With Windows 10



INFO

If the computer can already access the network in which the inverter is installed, these settings are not required.

5.3 Connecting the inverter and computer

Connecting the inverter with a computer

1. De-energise the inverter. 
2. Open the inverter cover.

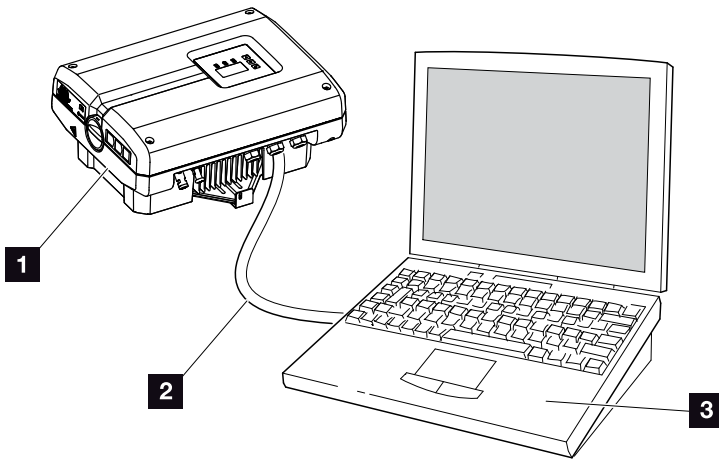



Fig. 51: Connecting inverter and computer with an Ethernet cable

- 1** Inverter
 - 2** Ethernet cable
 - 3** Computer (for configuration or data retrieval)
3. Connect the Ethernet cable to the RJ45 interface of the communication board. 
 4. Connect the Ethernet cable to the computer.
 5. Close the inverter cover.
 6. Activate fuses and DC switch.
- ✓ The inverter is connected to the computer.

Calling up Webserver

1. Launch an Internet browser.
 2. Enter the IP address of the inverter in the address line of the browser and confirm with "Enter". 
- The Webserver is called up.



TIP

You can find additional variants for connecting the inverter with a computer here  **Ch. 6.1**



DANGER

RISK OF DEATH DUE TO ELECTRICAL SHOCK AND DISCHARGE!

De-energise the device, secure it against being restarted and wait five minutes so that the capacitors can discharge.  **Ch. 4.3**



IMPORTANT INFORMATION

If the computer and the inverter are connected directly with an Ethernet cable, the adjacent work sequence must be followed!



TIP

The IP address can be queried in the inverter menu under "Settings/Communication/Network settings 2".

Additional entry options in the address line of the browser:

- S and the serial number of the inverter on the type plate (example: `http://S12345FD323456`)
- Name of the inverter: The inverter can be assigned a name. This may be no longer than 15 characters and may not contain special characters like + - * /... (For example: `http://SWR_5`).

- To log in, click on Login and select a user. The following log in data are preset as "Plant owner" as standard:

User name: pvserver

Password: pwvr



Enter the user name and password. 

- The Websserver's menu opens.

Undertaking settings in the Websserver

After logging in, the settings required can be undertaken on the inverter or values can be queried via the Websserver.

Disconnecting the inverter from the computer

- De-energise the inverter.
 **Ch. 4.3** 
 - Open the inverter cover.
 - Unplug the Ethernet cable from the inverter and the PC.
 - Close the inverter cover.
 - Activate fuses and DC switch.
- ✓ The inverter is once again in operation.



IMPORTANT INFORMATION

The password should be changed under Settings once you have logged in for the first time.

The password may consist of no more than 15 characters and contain the following characters: a-z, A-Z, 0-9 and _

You need a service code to log in as an installer. This can be requested from the Service team.  **Ch. 12.2**

Should you forget the password, this can be reset to the default values on the inverter by going to Service menu > «Reset web login».  **Ch. 4.8**



TIP

Leave the Ethernet cable connected to the inverter. This makes it possible to easily carry out further queries or setting configurations on the inverter.

If connecting through a router, for example, there is no need to remove the connection.



DANGER

RISK OF DEATH DUE TO ELECTRICAL SHOCK AND DISCHARGE!

De-energise the device, secure it against being restarted and wait five minutes so that the capacitors can discharge.  **Ch. 4.3**

5.4 Menu structure in web browser

The menus* of the Webserver are explained on the following pages.

*Deviations due to software versions (UI status) possible.

Home menu

 Home ————— Displays inverter status and the current power values

Current values menu

 Current values —————

- PV generator ————— Displays voltage, current, performance for each DC input
- House ————— Display home consumption
- Grid ————— Displays voltage, current, performance for each phase and total fed into the public grid
- Analog inputs ————— Displays voltages at the analog inputs on the communication board
- S0 input ————— Displays the function of the S0 input and the associated values

Statistics menu

 Statistics —————

- Day ————— Displays yield, home consumption, self-consumption, self-consumption rate and degree of self-sufficiency for the current day
- Total ————— Displays total yield, home consumption, self-consumption, self-consumption rate and degree of self-sufficiency
- Log data ————— Displays the history/log data stored in the inverter

Settings menu

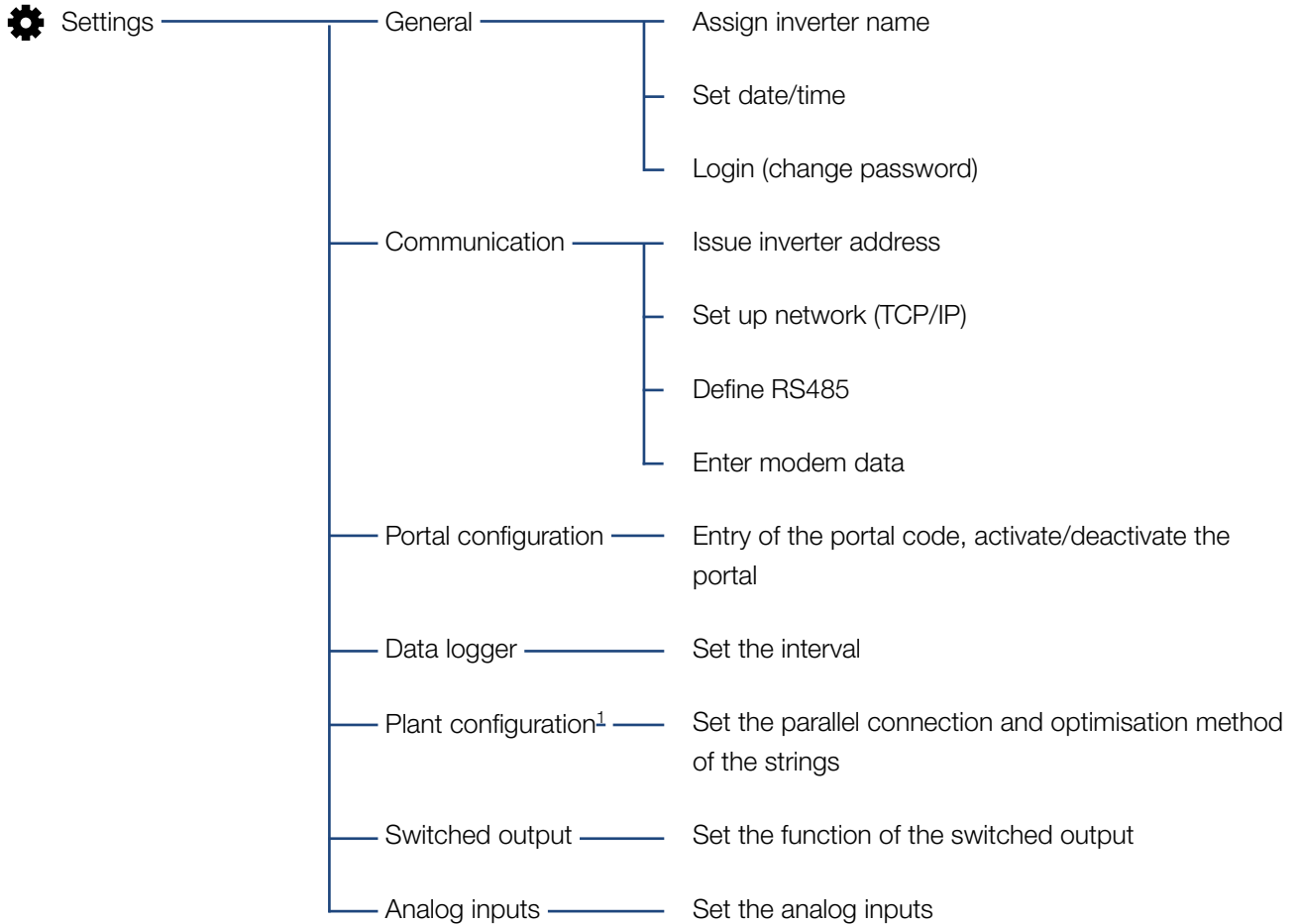

Info menu



Logout menu



¹ These settings are only possible with a service code

5.5 Webserver main menu

- **Home**

Displays the key information and yield data for the inverter.
- **Current values**

The various menu items allow the user to view the current values for the PV generators, the home consumption, the public grid connection, the analogue interfaces and the use of the SO/AL-Out contact on the communication board.
- **Statistics**

Shows information about the inverter's yield and consumption data and the daily or total home consumption. "Log data" shows the inverter's history data or stores it on the computer.
- **Settings**

These menu items allow you to configure the inverter (e.g. inverter name, network settings).
- **Info**

On the Info page the user can view events pending in the inverter or the inverter's installed versions (e.g. user interface, firmware, hardware). This information can also be viewed without logging in to the Webserver.
- **Login/Logout**

Allows the user to log into or out of the Webserver.
Login: Log in to the Webserver. You can log in as a plant owner or as an installer. As an installer you require a service code, which gives you additional setting options on the inverter.
Logout: Menu item to log out of the Webserver.

5.6 Webserver submenus

Webserver page "Login/Logout"

Allows the user to log into or out of the Webserver.

- **Login:** Log in to the Webserver. You can log in as a plant owner or as an installer. As an installer you require a service code, which gives you additional setting options on the inverter. 
- **Logout:** Menu item to log out of the Webserver.



INFO

You need a service code to log in as an installer. This can be obtained from the service team.  **Ch. 12.2**

Webserver page "Home"

- Displays information and yield data for the inverter.

Parameter	Explanation
Power values - total DC Input	Displays the generated energy of all PV generators.
Power values - output power	Shows how much power is fed into or drawn from the public grid.
Power values - self-consumption	Shows the home consumption covered by self-produced energy (this is not shown for 1-phase devices).
Status - operating status	Operational status of inverter. For more information, see  Ch. 4.5.

Webserver page "Current values"

Menu items to display the current energy values of the AC and DC side.

- **PV generator**

Displays the generated voltage, current and energy of the PV generators per DC input.

- **House**

Shows the current home consumption and how this is distributed over the phases.

"Current home consump." shows from which sources the home consumption is being covered (solar generator and public grid).

"Phase-sel. consumption" indicates how much energy is required on the individual phases.

Parameter	Explanation
Solar generator	Indicates the power consumption that is currently being covered from the PV modules.
Grid	Indicates the power consumption that is currently being covered from the grid.
Phase x	Indicates the power by phase (1, 2 or 3) that is covered by the PV modules and grid.

- **Grid**

Shows the current performance data of the grid side (AC) and how the energy is distributed to the phase.

Parameter	Explanation
Output power	Shows how much power is fed into or drawn from the public grid.
Grid frequency	Shows the current grid frequency.
Cos phi	Indicates the current reactive power (cos phi).
Limitation on	Shows the current power curtailment setting.
Phase x	Indicates the power by phase (1, 2 or 3) that is covered by the PV modules and grid.

- **Analog inputs**

Shows the voltage which is currently available on the analog input x. The meaning of the voltage data depends on the sensor used. In the case of an irradiation sensor, for example, it may be the intensity of solar irradiation. (For more information, refer to the manual for the sensor).

- **S0 input**

The "Number of energy pulses" shows the number of energy pulses per time unit on the S0 interface. If an external energy meter is connected at the S0 input, for example, the energy counted by the meter can be queried.

Webserver page "Statistics"

Displays the yield, daily consumption, total consumption and log data.

- **Day**

Shows the yield/consumption values for the current day.

Parameter	Function
Yield	Indicates the energy generated by the PV generators.
Home consumption	Indicates the energy consumed in the whole house.
Self-consumption	Indicates the rate of energy consumed in the house that is covered by PV energy.
Self-consumption rate	The self-consumption rate shows the ratio between self-consumption and the total energy generated by the PV generators.
Degree of self-sufficiency	The degree of self-sufficiency indicates what percentage of the house's total power requirement is covered by self-generated PV energy. The higher the value, the less energy has had to be purchased from the energy supplier.

- **Total**

Shows all yield/consumption values that have accumulated in the inverter.

Parameter	Function
Yield	Indicates the energy generated by the PV generators.
Home consumption	Indicates the energy consumed in the whole house.
Self-consumption	Indicates the rate of energy consumed in the house that is covered by PV energy.
Self-consumption rate	The self-consumption rate shows the ratio between self-consumption and the total energy generated by the PV generators.

Parameter	Function
Degree of self-sufficiency	The degree of self-sufficiency indicates what percentage of the house's total power requirement is covered by self-generated PV energy. The higher the value, the less energy has had to be purchased from the energy supplier.
Operation time	Indicates the run time of the inverter.

■ Log data

The link calls up the measured values (log data). The log data of the inverter can be downloaded as a DAT file (logData.dat). The data in the file is in CSV format and can be viewed with any spreadsheet program (e.g. Excel). For more information, see [🔗 Ch. 6.2](#).

Option **"Open"**:

The data are displayed in a new or the same browser window.

Option **"Save"**:

The data (LogDaten.dat) are saved on your hard drive. After saving, this data can be displayed and further processed. 



INFO

If the inverter is not connected to a solar portal, regular backup copies of the log data should be created.

Webserver page "Settings"

In Settings you can configure the inverter and the external components (e.g. sensor, ripple control receiver). 

- **General**

Set the general parameters of the inverter.

Menu item	Function
Inverter name	Enter the inverter name. The characters a-z, A-Z, 0-9 and " _ " are allowed for the name change. Spaces or special characters are not possible. The browser connection to the Webserver can take place with the new name following the name change. Access with the serial number remains possible.
Date/time	Enter the time and date. It is possible to adopt the PC time using the button "Set to PC time".
Login	Change current password



INFO

The entries must be confirmed with a click on the "Accept" button. The settings are then saved.

■ **Communication**

Set the communication parameters of the inverter.

Menu item	Function
Inverter address	Input RS485 address of inverter. When two or more inverters are connected via RS485, each inverter must be given its own RS485 address.
Network (TCP/IP)	Input network, gateway and DNS server configuration. Configuration of the inverter network interface (Ethernet). As the standard default setting, the option "Auto IP/DHCP" and "Router/Gateway" is activated. 

Network configuration

Auto-IP/DHCP

Manually

IP address: . . .

Subnet mask: . . .

Router/Gateway: . . .

DNS Server: . . .

Data export

Router/Gateway

Inverter with modem

Network info

IP address: 168.192.2.32

Subnet mask: 255.255.255.0

Router/Gateway: 168.192.2.1

DNS Server 1: 168.192.2.1

DNS Server 2: 0.0.0.0

MAC address: 00:80:41:ae:fd:7e



INFO

As the standard default setting, the option "Auto IP/DHCP" is activated. This means that the inverter acquires its IP address from a DHCP server or automatically generates an IP address.

If the inverter is not allocated an automatic IP address through a DHCP server, the inverter can be configured using "Manually".

The data necessary for configuration, such as IP, router and DNS addresses, can be found on your router/gateway.

If the inverter is connected to a "Router/Gateway", the "Router/Gateway" option must be activated.

If data export using "Inverter with modem" is selected, communication is carried out through an inverter's modem. This can be installed in your own or another inverter.

"Network info" shows the addresses which the inverter is currently using. If the router/gateway also functions as a DNS server, the same IP address is displayed under DNS Server 1. If an alternative DNS server is issued through the "Manual" setting, the IP address for this is displayed under DNS Server 2.

Menu item	Function
RS485	<p>Bus termination: The bus termination must be activated on devices which are at the end of the RS485 bus.</p> <p>Bus bias voltage: At least one device in an RS485 bus system must supply the bus voltage. Activation means that the inverter supplies the bus bias voltage.</p> <p>Protocol: Selection of protocol used on the bus. </p> <p>KOSTAL: Is used to make more PIKO inverters or an external data logger/energy manager accessible via the interface.</p> <p>Modbus: Is used to connect, for example, external data loggers/energy managers to the RS485</p> <p>Baud rate: Selection of the baud rate, which is to be used for the bus system.</p> <p>Inverter address: Shows the inverter's set RS485 address.</p>
Modem	<p>Shows the modem status. When the GSM modem is connected correctly, the GSM signal strength is displayed. When the modem is connected incorrectly or not available, "No modem available" is displayed.</p> <p>GSM-PIN: PIN of SIM card.</p>



INFO

A precise description of the protocol used (e.g. TCP, RS485, KOSTAL, Modbus-RTU), can be requested from the Service team.

■ **Portal configuration**

Enter the solar portal configuration. If you want to use a solar portal, the log data and events can be sent to the solar portal

Menu item	Function
Portal code	Input box for the portal code of a solar portal (e.g. PIKO Solar Portal - P3421).
Active portal	Display of the active portal.
Last portal connection	Displays how many minutes ago the inverter last transferred data to the solar portal (when the function is active).
Data export	Removal of the "check" deactivates sending to the solar portal.

■ **Data logger** 

Choose from a saving interval of 5, 15 or 60 minutes.



INFO

When 5 minutes is selected, the data can be saved for approximately 130 days. When 15 minutes is selected, the data can be saved for approximately 400 days. When 60 minutes is selected, the data can be saved for approximately 1500 days. When the internal memory is full, the oldest data will be overwritten.

■ **Plant configuration (only with service code)**

Possible settings for activating parallel connection of generators or a variant of MPP tracking optimisation.



Menu item	Function
Parallel connection (with service code only)	Parallel connection can be activated or deactivated here depending on the connection of DC inputs DC1 and DC2 in the inverter. The string connection can only be adjusted for inverters with at least 2 DC inputs. A detailed description of parallel connection can be found in the chapter Ch. 3.5
Plant management	<p>Shadow management: If PV strings are in partial shading, the PV string affected no longer achieves its optimum performance. If shadow management is activated, the inverter adapts the MPP tracker of the selected PV string such that it can operate at maximum possible performance. The function can be activated for each individual string. </p> <p>External module control: If PV modules with their own MPP tracker optimisation are connected to the inverter, the assistance of this external module control can hereby be activated. </p>



INFO

Not possible with PIKO 3.0.



INFO

If the DC inputs DC1 and DC2 are connected in parallel, they can no longer be optimised using shadow management.



INFO

A list of approved optimisers and external module controls can be found in the Download area on our homepage.



■ **Switched output**

Set the function of the S0 switched output on the communication board. The 2-pin terminal can be assigned various functions.

Parameter	Function
S0 pulses	The switched output functions as a pulse output as described in EN 62053-31 with a constant rate of 2,000 pulses per kilowatt hour. This function is a factory setting.
Alarm output	The switched output functions as a potential-free NC contact. It is opened when an event occurs.
Self-consumption control	The switched output functions as a potential-free NO contact. It closes when the set conditions are fulfilled. Detailed description in chapter Self-consumption.  Ch. 8.1
Dynamic self-consumption control	

■ **Analog inputs**

Two settings are possible here.

Menu item	Function
Sensors	If a sensor (e.g. PIKO Sensor) is connected.
Active power control	For the connection of a ripple control receiver.  Detailed description in chapter Self-consumption.  Ch. 7.1



IMPORTANT INFORMATION

The ripple control receiver may only be connected at the master inverter.

Webserver page "Info"

Displays all events and version numbers of the inverter.

■ Events

Call up events that have been stored in the inverter.

Event messages can be faults or other events.

Remedial measures can be found in the "Event codes" chapter  **Ch. 4.10**.

■ Versions

Shows information about the versions installed on the inverter. This information can also be viewed without logging in to the Webserver.

Function	Meaning
UI	User interface version
FW	Firmware version
HW	Hardware version
PAR	Version of set of parameters
Serial number	Inverter serial number
Article number	Article number of the inverter
Country setting	Shows the inverter's country setting

6. System monitoring



6.1	Create connection between computer and inverter	107
6.2	The log data	110
6.3	Retrieve, save and graphically represent log data	113

6.1 Create connection between computer and inverter

It is possible to connect the inverter with a computer in the following cases:

- Settings and retrievals in the Webserver.
- Retrieve log data of the inverter.

Inverter and computer can be connected with the following variants:

- **Variant 1**  **Page 108**
Connect the inverter and computer directly
- **Variant 2**  **Page 108**
Connect inverter and computer by way of a switch/hub/router

Variant 1: Connect the inverter and computer directly

This variant is mainly used for configuring the inverter by way of the Webserver on location if the inverter is not being integrated in a network. **!**

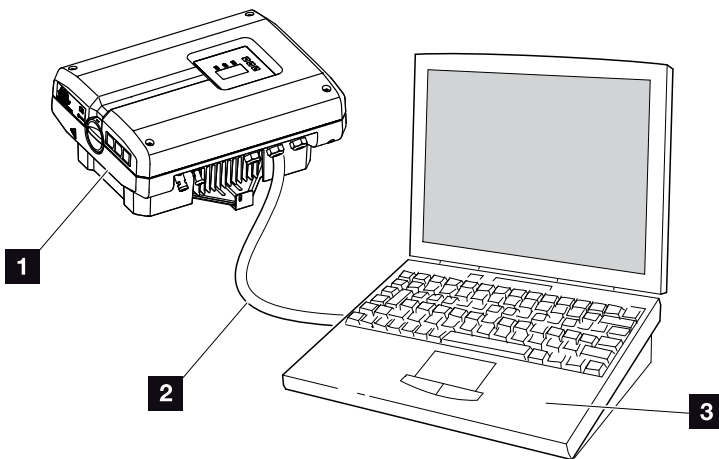

Fig. 52: Connect the inverter and computer directly

- 1** Inverter
- 2** Ethernet cable
- 3** Computer (for configuration or data retrieval)

Variant 2: Connect inverter and computer by way of a switch/hub/router

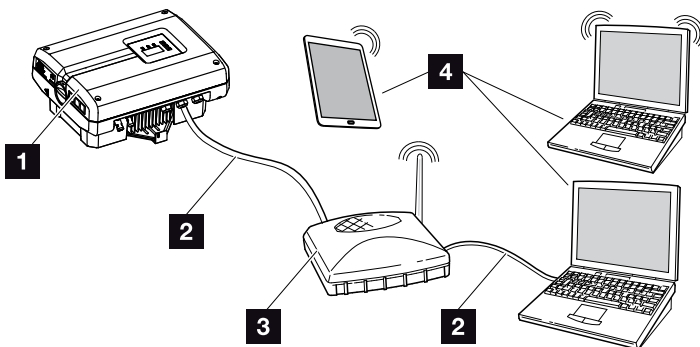

Fig. 53: Connect inverter and computer by way of a router

- 1** Inverter
- 2** Ethernet cable
- 3** Switch/hub/router with or without WLAN
- 4** Computer via LAN or WLAN (for configuration or data retrieval)



IMPORTANT INFORMATION

Use a patch cable of category 6 (Cat6e) with a maximum length of 100 m.

Manually configuring the network

As the standard default setting, the option "Auto IP/DHCP" and "Router/Gateway" is activated. This means that the inverter obtains its IP address from a DHCP server or automatically generates an IP address and establishes the connection to the Internet through an external router/gateway.



In the following case, the network setting must be entered manually:

- No DHCP server to generate an IP address

A DHCP server can be, for example, an Internet router (cable/DSL). A DHCP server (Dynamic Host Configuration Protocol) is a service that administers and distributes the IP addresses and the network configuration in a network.

If the IP address has to be set manually, this can be done in the inverter menu below or above the Webserver under "Communication".

6.2 The log data

The inverter is equipped with a data logger  **Tab. 3**, which regularly records the following data from the system: 

- Inverter data
- Data from external current sensors
- Grid data
- ENS data

You can find out how to retrieve, save and graphically represent log data in the following chapter  **Ch. 6.3**

The log data can be used for the following purposes:

- Check operating characteristics of the system
- Determine and analyse errors
- Download and graphically represent yield data



INFO

The log data can be downloaded as a DAT or as a TXT file.

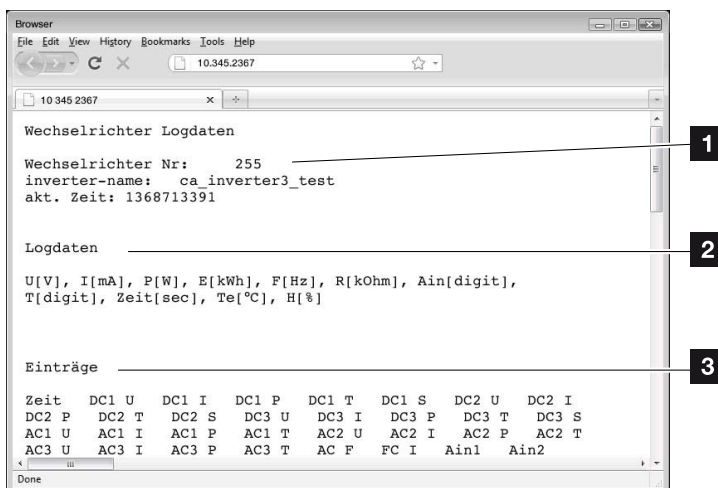



Fig. 54: Example screen "The log file"

- 1 File header
- 2 Physical variables
- 3 Entries in the log file

Log file: File header

The log file contains a file header with information on the inverter:

Entry	Explanation
Inverter number	Number of the inverter
Name	Can be assigned by the user via the browser
Current time	The system time valid at the point in time of file creation in seconds. This makes allocation possible (e.g. 1372170173 Unix time stamp = 25.06.2013 16:22:53) 



INFO

Unix time stamp converter can be found on the Internet.

Tab. 7: Log file file header

Log file: Physical variables

The file header is followed by the units of the physical variables. The following table explains the abbreviations for the physical variables:

Entry	Explanation
U	Voltage in volts [V]
I	Current strength in milliamps [mA]
P	Power in watts [W]
E	Energy in kilowatt hours [kWh]
F	Frequency in Hertz [Hz]
R	Resistance in kilohms [kOhm]
T	Counting unit in points [digits]
Aln	Counting unit in points [digits]
Time	Time in seconds [sec] since the inverter was put into operation
TE	Temperature in Celsius [°C]
H	Without function

Tab. 8: Physical variables in the log file

Log file: Entries

The units of the physical variables are followed by various entries in the log file.

The following table explains the various entries of the log file and may deviate depending upon the model:

Entry	Explanation
Time	Time in seconds of the time since the inverter went into operation
DCx U	DC voltage: Input voltage of the respective string (x = 1, 2 and 3) in V
DCx I	DC current: Input current of the respective string (x = 1, 2 and 3) in mA
DCx P	DC power: Input power of the respective string (x = 1, 2 and 3) in W
DCx T	DC temperature: Details for service. Temperature of the respective phase (x = 1, 2 and 3) in digital values
DCx S	DC status: Details for service of the respective string (x = 1, 2 and 3)
ACx U	AC voltage: Output voltage of the respective phase (x = 1, 2 and 3) in V
ACx I	AC current: Output current of the respective phase (x = 1, 2 and 3) in mA
ACx P	AC power: Output power of the respective phase (x = 1, 2 and 3) in W
ACx T	AC temperature: Details for service. Temperature of the respective phase (1, 2 and 3) in digital values
AC F	AC frequency: Grid frequency in Hz
FC I	Residual current: Measured residual current in mA
Aln1 Aln2 Aln3 Aln4	Analog input voltage: Display of the analog inputs 1 to 4 of the communication board. The measured voltage value in V can be calculated with the value from the table (digits) and the following formula: Input voltage [V]=(10/1024) * digits. If the S0 input is used to count the energy pulses, both table columns Aln3 and Aln4 give the sum of the energy pulses per log interval. This total value is calculated as follows: $E_{total} = Aln3 * 2^{16} + Aln4$
AC S	AC status: Details for service of the operational status of the inverter
ERR	General malfunctions
ENS S	Status of the ENS (device for grid monitoring with assigned switching elements): Status of grid monitoring
ENS Err	Malfunctions of the ENS (device for grid monitoring with assigned switching elements)
SHx P	External current sensor power: Power of the respective phase (x = 1, 2 and 3) in W
SCx P	Self-consumption at the respective phase* (x = 1, 2 and 3) in W
HC1 P	not used
HC2 P	Home consumption in W from the PV modules
HC3 P	Home consumption in W from the grid
KB S	Internal communication status when switching to AC grid
Total E	Total energy: Total fed-in energy in kWh when switching to AC grid
HOME E	Home consumption: Energy currently used in the household in kWh
Iso R	Insulation resistance in kohm when switching to AC grid
Event	POR event, "power on reset": renewed start-up of communication after a loss of AC voltage.

Tab. 9: Log data

6.3 Retrieve, save and graphically represent log data

There are several variants for retrieving and permanently saving the log data:

- **Variant 1:** Download the log data with a computer and display it
- **Variant 2:** Transfer log data to a solar portal and display it

Variant 1: Download the log data with a computer and display it

1. In the Webserver, go to the "Log data" page under "Statistics".  **Ch. 5.2**
 2. Save the file *LogDat.dat* on the computer.
 3. Open the file *LogDat.dat* in Excel.
- ✓ The log data are represented in table form and can be processed further.

Variant 2: Transfer log data to a solar portal and display it

With a solar portal it is possible to monitor the PV system and the performance data via the Internet.

A solar portal has the following functions, which, however, may differ depending upon the portal:

- Graphic representation of performance data
- Worldwide online access to the portal
- E-mail notification of errors
- Data export (e.g. Excel file)
- Long-term storing of log data

Prerequisites for data transfer to a solar portal:

- ✓ Inverter has an Internet connection
- ✓ Logged on to a solar portal (e.g. PIKO Solar Portal)
- ✓ Portal code of solar portal (e.g. P3421)
- ✓ Activation of data transfer in the inverter

Activate data transfer to a solar portal via the control panel

1. Select the "Settings" menu on the control panel of the inverter.
2. Confirm with the "ENTER" key.
3. Use the "UP", "DOWN" and "ENTER" keys to select the "Communication"/"Portal configuration" menu.
4. Enter the portal code of the solar portal in the "Code:" field. The portal code can also be assigned via the Webserver under "Portal configuration". The portal code for the PIKO Solar Portal (www.piko-solar-portal.de) is P3421.



INFO

A correctly set-up network connection/Internet connection is a prerequisite for data transfer

It may take as much as 20 minutes following activation (dependent upon the portal) until the data export is visible on the solar portal.

The transfer time may increase if the connection is impaired (e.g. poor wireless connection).

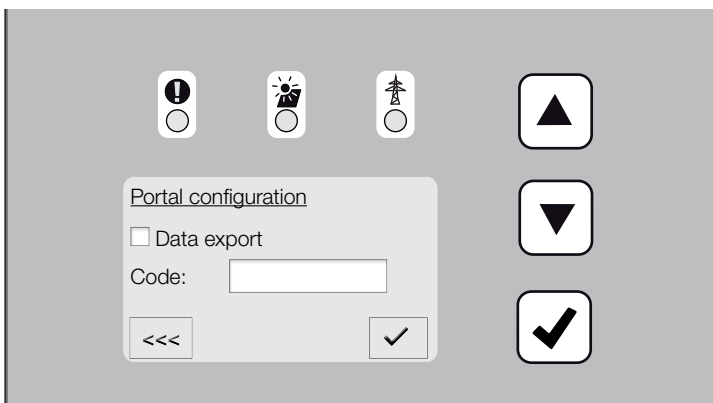

Fig. 55: Entry of the portal code

5. Press and hold down the "ENTER" key for approximately 3 seconds.
6. Select the "Accept" field and confirm with "ENTER".

- ✓ The data transfer to the solar portal is active (recognisable from the X in front of "Data export"). The name of the solar portal is shown. The data export to the solar portal is being executed.

7. Active power control

7.1	Why active power control?	117
7.2	Limitation of the PV feed-in capacity	118
7.3	Activate power control with a ripple control receiver	119
7.4	Install the ripple control receiver	120

7.1 Why active power control?

In Germany, VDE application rule (VDE-AR-N 4105) and Renewable Energies Act (EEG) 2012

Several energy supply companies offer the owners of PV systems the possibility to regulate their system with variable active power control, and thus to increase the feed-in to up to 100 %. The VDE application rule (VDE-AR-N 4105) and the Renewable Energies Act, for example, currently exist in Germany for this purpose.

These application rules require active power control (reduction of the feed-in capacity) for each PV system.

The planner of a PV system can choose between two types of active power control: 

- Limitation of the feed-in capacity to 70 % of the PV power at the grid connection point
- Activate power control with a ripple control receiver



INFO

Should the PV system not fulfil the requirements of the German Renewable Energies Act, the grid operator can reduce the feed-in tariff or dispense with it entirely.



INFO

When selecting active power control, check to determine which of the two possibilities offers the better energy yield.

7.2 Limitation of the PV feed-in capacity

Should the active power control not be realisable with a ripple control receiver, the feed-in capacity is then to be reduced to 70 % of the PV power according to the German Renewable Energies Act 2012 (EEG 2012).

The power limitation is carried out with the parameterization software PARAKO. This software is available from Support.

The PIKO BA Sensor can be used with systems for which a limitation of the feed-in capacity, for example to 70 %, is to be set as an affordable alternative to the ripple control receiver. 

The current consumed in the building itself can be determined with the help of the PIKO BA Sensor. The intelligent self-consumption optimisation of the inverter can in this way increase the output power accordingly and maximise the yield. The power fed into the grid thereby remains limited to a maximum of 70 %.



INFO

The mode of the PIKO BA Sensor can be set in the service menu. To change the settings the installer requires a service code.

7.3 Activate power control with a ripple control receiver

The active power of the PIKO inverter can be controlled directly by the energy supply company via a ripple control signal receiver. **i**

With this technology, the generated power can be regulated at four levels: **i**

- 100 %
- 60 %
- 30 %
- 0 %

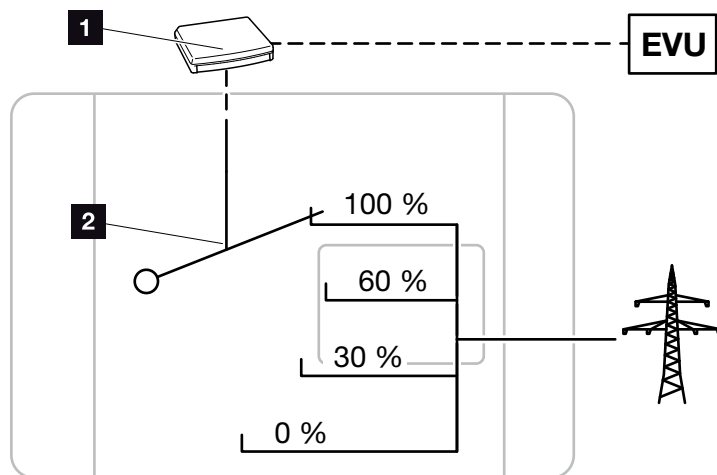

Fig. 56: Activate power control with a ripple control receiver

- 1** Ripple control receiver
- 2** Control electronics of the inverter



INFO

For all PIKO inverters, the ripple control signal receiver can be directly connected without an additional device.



INFO

The four standard specifications for the power limitation can be changed using the parameterization software PARAKO. However, the provisions of the energy supply company must be observed.

7.4 Install the ripple control receiver

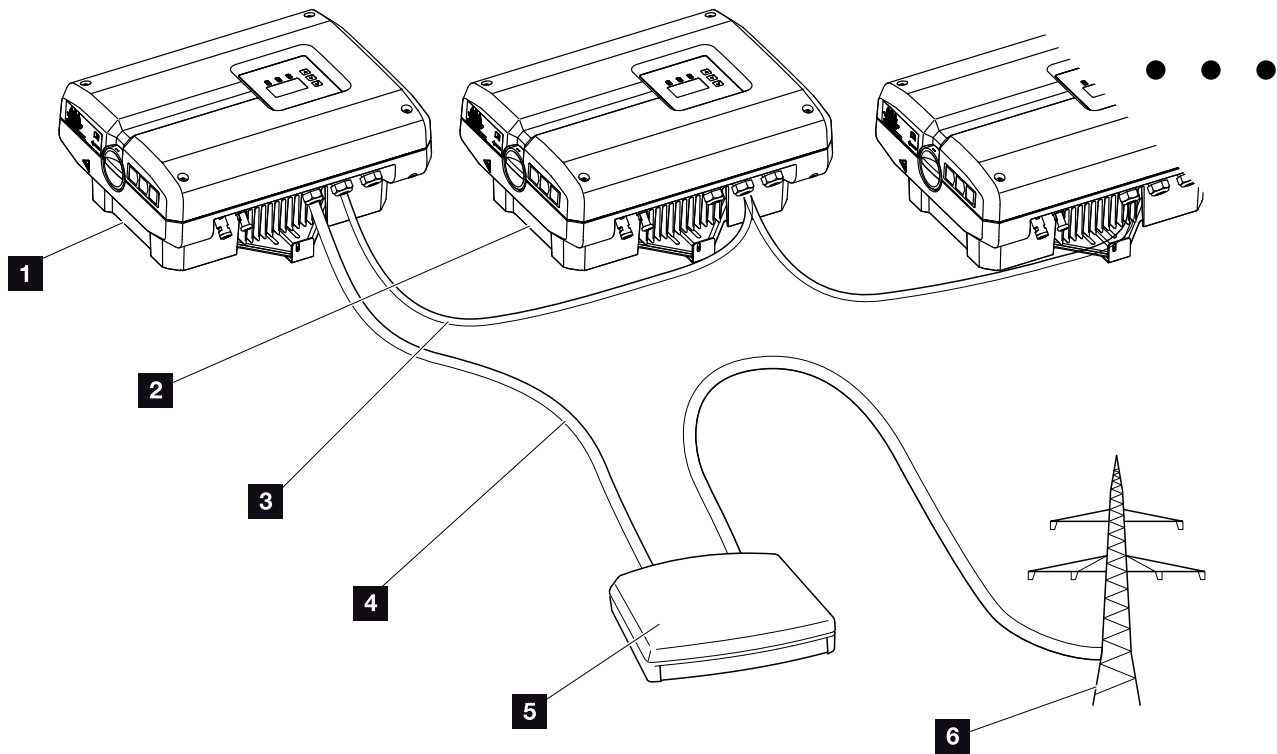

Fig. 57: Configuration of the ripple control receiver with several inverters (Ethernet networking)

- 1 Master inverter
- 2 Additional inverters (slaves)
- 3 Ethernet or RS485 cable
- 4 5-conductor connection
- 5 Ripple control receiver
- 6 Energy supply company

Connect the ripple control receiver

1. De-energise the inverter.
🔗 **Ch. 4.3** ⚠️
2. Connect all inverters via the Ethernet connections (RJ45) with an Ethernet cable or by means of RS485.
🔗 **Fig. 57**
3. Connect the ripple control receiver to the master inverter 🔗 **Fig. 57 It. 1** on the terminal (10-pin).
🔗 **Fig. 58** ⚠️

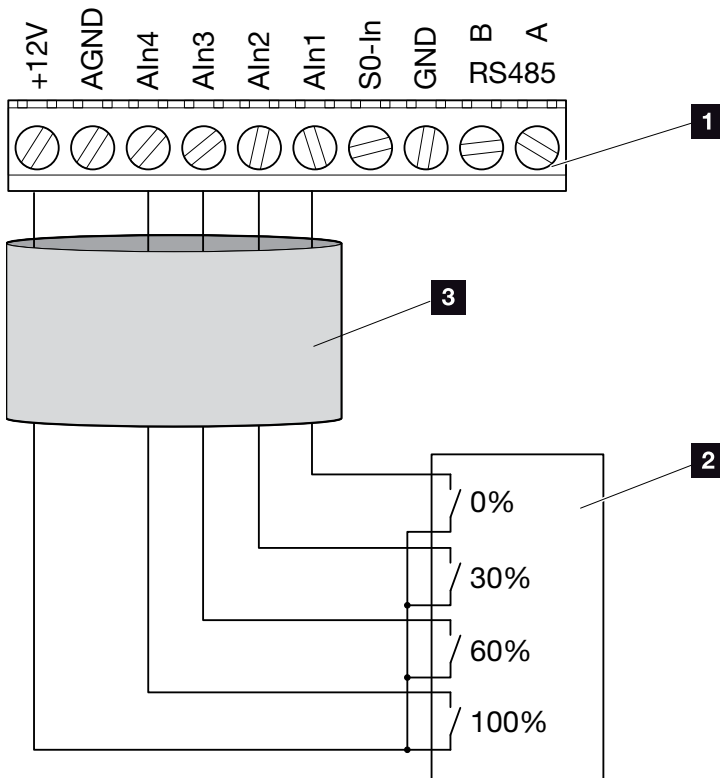

Fig. 58: Connection of ripple control receiver

- 7 Terminal (10-pin)
- 8 Ripple control receiver
- 9 Cable

✓ The ripple control receiver is connected.



DANGER

RISK OF DEATH DUE TO ELECTRICAL SHOCK AND DISCHARGE!



De-energise the device, secure it against being restarted and wait five minutes so that the capacitors can discharge. 🔗 **Ch. 4.3**



IMPORTANT INFORMATION

The ripple control receiver may only be connected at the master inverter. 🔗 **Fig. 57**

Activate the active power control function in the Webserver

1. Connect the inverter and computer with an Ethernet cable.  **Ch. 6.1** 
2. Launch an Internet browser.
3. Enter the IP address of the master inverter in the address line of the browser and confirm with "Return". 
- The input screen for the access data opens.
4. Enter your user name and password.
- The Webserver opens.
5. Select "Settings" > "Analog inputs".
- "Analog inputs" opens.
6. Select the function "Active power control".
7. Click on the "Accept" button.
- ✓ The active power control for the ripple control receiver is active.



IMPORTANT INFORMATION

The configuration must be carried out at the master inverter to which the ripple control receiver is connected.

No adjustments may be made on the other inverters.



INFO

The IP address can be queried by way of the control panel in the "Settings" menu.

The IP address is found in the inverter menu under "Settings/Communication/Network settings 2".

Additional entry options in the address line of the browser: S and the serial number of the inverter on the type plate (example: <http://S12345FD323456>)

8. Self-consumption

8.1	Self-consumption overview	124
8.2	Electrical connection for self-consumption	125
8.3	Set up self-consumption control in the Webserver	126

8.1 Self-consumption overview

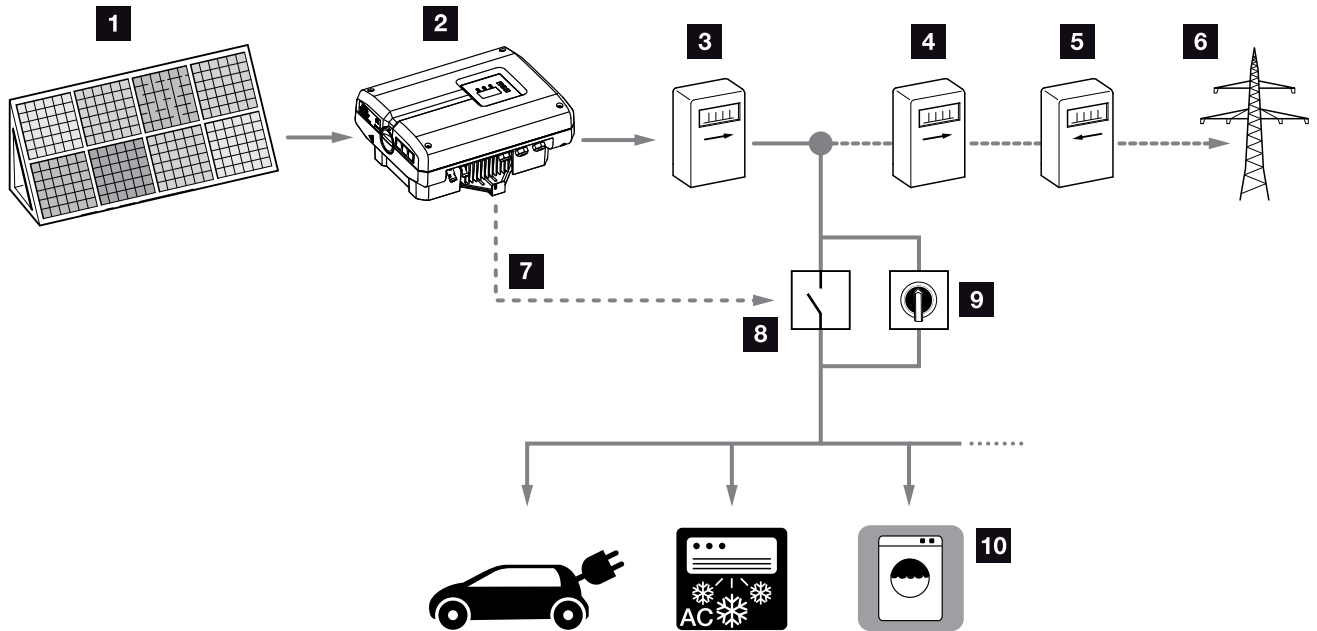

Fig. 59: Configuration of self-consumption

- 1 Photovoltaic modules
- 2 Inverter
- 3 Production meter
- 4 Feed meter
- 5 Consumption meter
- 6 Grid
- 7 Control signal from communication board (S0/AL-Out terminal)
- 8 External load relay
- 9 Jumper switch
- 10 Consumer device

All inverters are designed in such a way that the generated current can be used for self-consumption. !



IMPORTANT INFORMATION

The self-consumption control function on the S0/AL-Out contact is deactivated in the event of EMERG power supply in conjunction with a PIKO BA Backup Unit.

8.2 Electrical connection for self-consumption

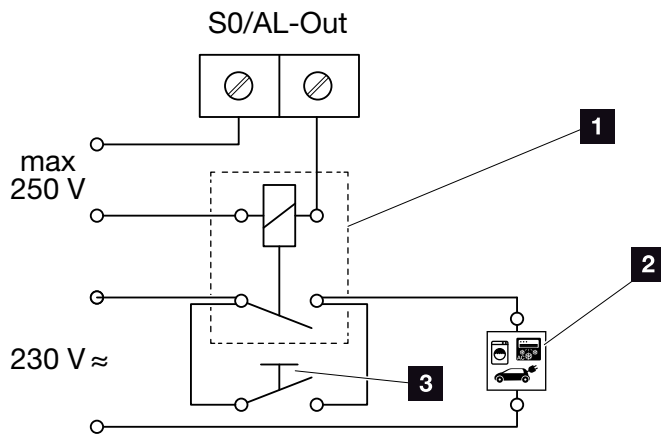





Fig. 60: Electrical connection for self-consumption

- 1** Load relay
- 2** Consumer device
- 3** Jumper switch

Proceed as follows for the electrical connection for self-consumption:

1. De-energise the inverter.  **Ch. 4.3**
 2. Properly connect the load relay to the terminal S0/AL-Out on the communication board.
 3. Properly install and connect the additional components for self-consumption.  **Fig. 59**
- ✓ The electrical connection for self-consumption is complete. 

S0/AL-Out switched output on communication board

Max. load	100 mA
Max. voltage	250 V (AC or DC)

Tab. 10: Technical data for S0/AL-Out switched output



DANGER

RISK OF DEATH DUE TO ELECTRICAL SHOCK AND DISCHARGE!

De-energise the device, secure it against being restarted and wait five minutes so that the capacitors can discharge.  **Ch. 4.3**



DAMAGE POSSIBLE

An external load relay must be installed between inverters and devices. No consumers may be connected directly to the inverter!

8.3 Set up self-consumption control in the Webserver

Switched output function:

Self-consumption control

Function 1

Power limit W

Stable positive deviation from the limit min

Run time min

Activation number/day

Function 2

Activation limit W

Deactivation limit W









Delay in drop in output/fault min

Fig. 61: Self-consumption control functions for Webserver

The following settings are required in the Webserver in "Settings" > "Switched output function":

- 1 Switched output function
- 2 Self-consumption control function 1 or 2
- 3 Delay in drop in output/fault

Set up self-consumption control

1. Properly connect the external load relay to the S0/AL-Out terminal  **Fig. 60**
 2. Connect the inverter and computer with an Ethernet cable.  **Fig. 52**
 3. Launch an Internet browser.
 4. Enter the IP address of the master inverter in the address line of the browser and confirm with "Return".
 5. Log on to Webserver with user name and password.
 6. In the Webserver, go to "Settings" > "Switched output" and select the function "Self-consumption control" or "Dynamic self-consumption control".
 **Fig. 61, It. 1** 
 7. Choose function 1 or function 2.
 **Fig. 61, It. 2** 
 8. Enter values for the function.
 9. Activate and enter optional value for "Delay in drop in output/fault" with a check box.  **Fig. 61, It. 3** 
 10. Click on "Accept".
 11. Start up the inverter.
- ✓ The self-consumption control function is active.



INFO

When selecting "Dynamic self-consumption control", the measured home consumption determined with the PIKO BA Sensor available as an option is automatically added to the set value and taken into consideration.



INFO

- You can find more detailed explanations regarding the selection of function 1 or 2 in the course of the chapter.
- The command "Delay in drop in output/fault" can be used for function 1 and 2.

Self-consumption control function 1

Control of self-consumption by time

When a certain rating **P1** has been generated for a certain period of time **T1**, the inverter switches to self-consumption. **i**

The inverter remains in self-consumption mode for the entire run time **T2**. Following the run time **T2**, the inverter ends self-consumption.

This is the end of the interval. This interval can be repeated several times with the "Activation" option.



INFO

When selecting "Dynamic self-consumption control", the measured home consumption P_c determined with the PIKO BA Sensor available as an option is automatically added to the set power limit P_1 and taken into consideration.

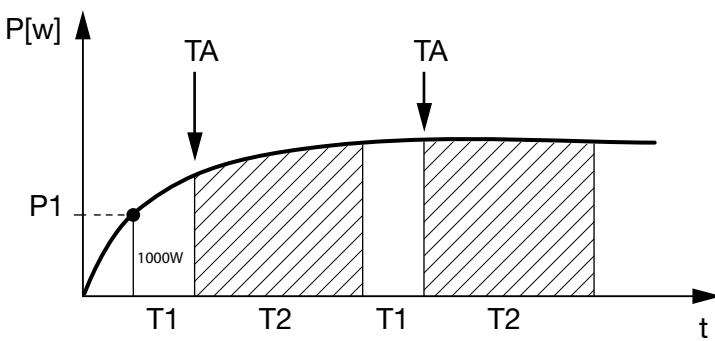

Fig. 62: Self-consumption graph (Function 1) without current sensor

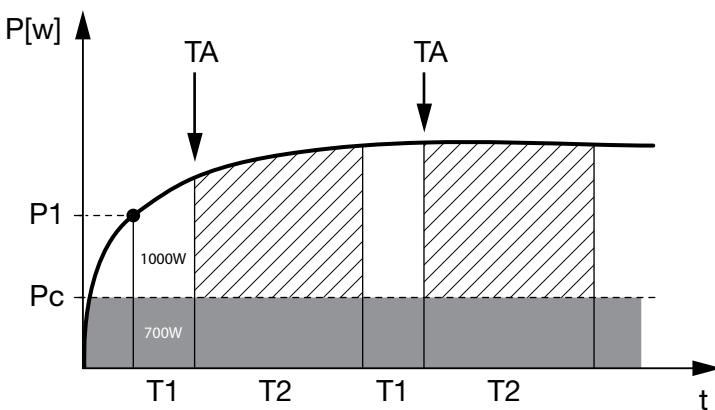

Fig. 63: Dynamic self-consumption graph (Function 1) with current sensor

P1: Power limit

This is the minimum power (in watts) that must be produced (e.g. 1000 W) before the consumer is switched on. You can enter any value from 1 watt to 999 000 watts.

T1: Period of stable exceeding of the output limit (P1)

The inverter must exceed the set "power limit" for this period of time (in minutes) before the consumer is switched on. You can enter any value from 1 to 720 minutes (= 12 hours).

T2: Run time

The connected consumer is switched on for this period (in minutes) when both of the above conditions have been met. You can enter any value from 1 to 1440 minutes (= 24 hours).

The run time ends when the inverter shuts off. The run time is ended and not continued again if the inverter has not produced any current for three hours.

TA: Activation**Dashed area: Self-consumption at S0/AL-out active**

The number **TA** (number/day) indicates how often self-consumption is activated each day.

Pc: Level of self-consumption**Grey area: Self-consumption in home network**

This is taken into account in the dynamic self-consumption control. Means the contact is only closed when power limit P1 less the self-consumption reaches the set value.

Self-consumption control function 2

Control of self-consumption by rating

When a certain rating **P1** has been generated (e.g. 1000 W), the inverter switches to self-consumption.

When the rating **P2** is not achieved (e.g. 700), the inverter ends self-consumption and resumes feeding current into the grid. **i**

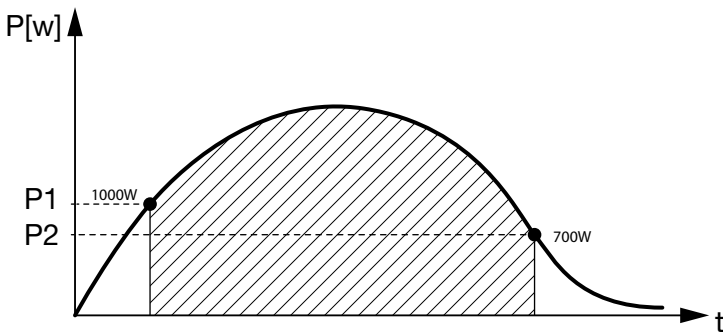

Fig. 64: Self-consumption graph (Function 2) without sensor



INFO

When selecting "Dynamic self-consumption control", the measured home consumption P_c , e.g. 500 W, determined with the PIKO BA Sensor available as an option is taken into consideration and automatically added to the set power limit $P1$, e.g. 1000 W, and $P2$, e.g. 700 W. This means that the contact does not close until 1500 W and opens again at 1200 W.

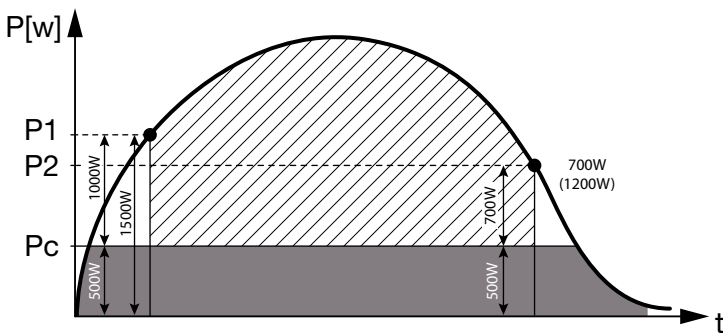

Fig. 65: Dynamic self-consumption graph (Function 2) with sensor

P1: Activation limit

This is the minimum power (in watts) that must be produced before the consumer is activated.

You can enter any value from 1 watt to 999 000 watts.

P2: Deactivation limit

The consumer is switched off when the power generated falls below this value.

Dashed area: Self-consumption active

In this power range, self-consumption is activated.

Pc: Self-consumption in the home network

The grey area shows the current self-consumption in the home network. This is taken into account in the dynamic self-consumption control. Means the contact is only closed when activation limit P1 less the self-consumption reaches the set value P1. The contact is opened when deactivation limit P2 less the self-consumption reaches the set value P2.

Delay in drop in output/fault

Delay time for switching off self-consumption

With this function, self-consumption is only discontinued after the set delay time **T1**. In the event of power loss, fault (**Tx**) and the failure to achieve the shutdown limit, the consumer remains switched on for the set time (**T1**).

If the fault period or the period of power loss is shorter than the set delay time, self-consumption remains activated.

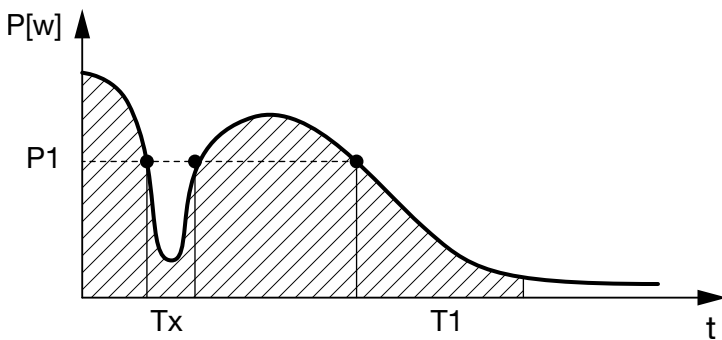

Fig. 66: Brief delay in drop in output/fault

P1: Power limit

T1: Delay time in the event of power loss/fault

Tx: Fault, power loss or failure of the inverter

Dashed area: Self-consumption active





9. Maintenance

9.1	Maintenance and service	134
9.2	Fan cleaning	135
9.3	Update software (communication board)	139
9.4	Update software (inverter firmware)	141
9.5	Update software (country settings)	142

9.1 Maintenance and service

Once correctly installed, the inverter runs virtually maintenance-free.

The following maintenance tasks are to be carried out for the inverter:

Activity	Interval
Carry out fan test ¹⁾ and check whether the fans function properly. Clean fans as required  Ch. 9.2 	1x annually or after an incident
Check cable connections and plugs	1x annually
Clean fans  Ch. 9.2 	1x annually

Tab. 11: Maintenance list

If no maintenance work is carried out, this results in an exclusion of the warranty (see 'Exclusion of warranty' in our Service and warranty conditions).

¹⁾ The fan test can only be performed in feed-in mode (green LED lit).



DAMAGE POSSIBLE

Dirty or blocked fans mean that the inverter is not adequately cooled. Insufficient cooling of the inverter can result in a reduction in performance or the failure of the system.

Always mount inverters in such a way that falling parts cannot fall into the inverter through the ventilation grille.

9.2 Fan cleaning

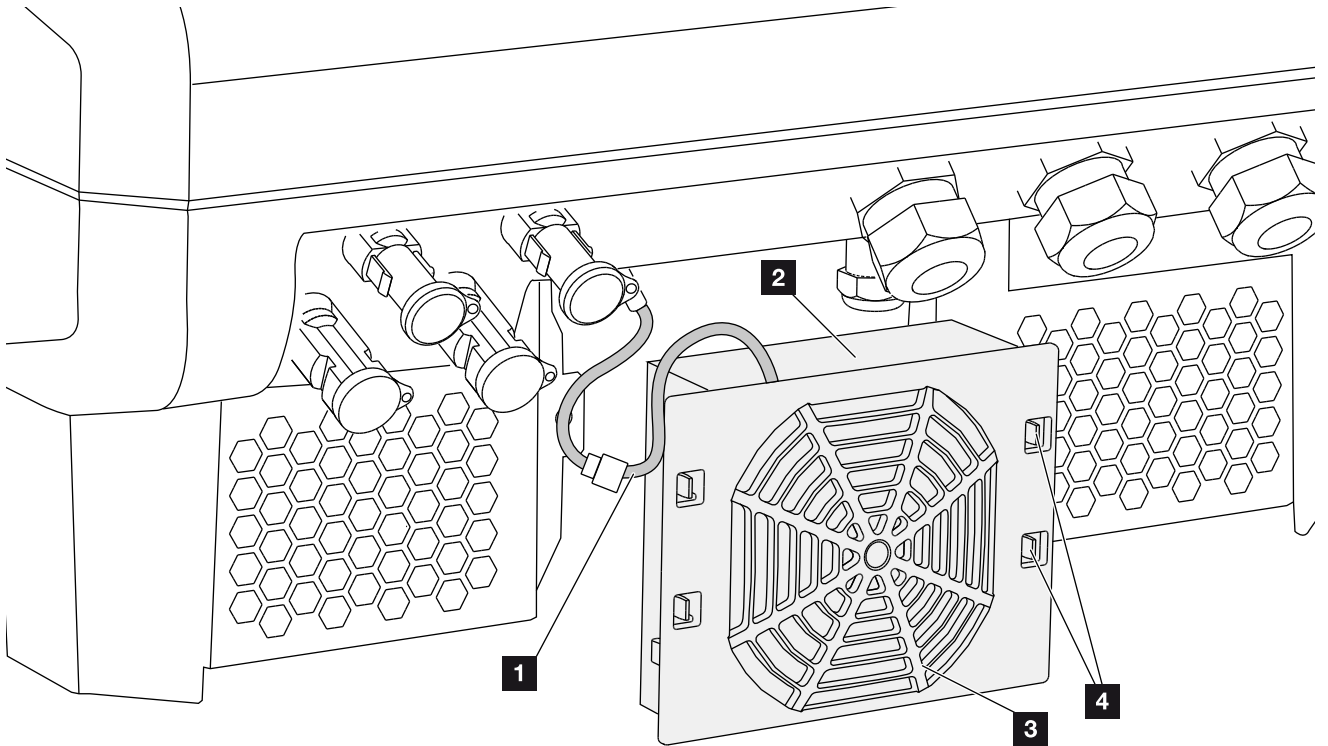

Fig. 67: Fan disassembly overview

- 1** Fan cable
- 2** Fan
- 3** Fan grill
- 4** Fastening straps

Procedure

1. De-energise the inverter ⚠️
 ↗️ **Ch. 4.3**
2. Dismantle the fan. To do this, place a screwdriver at the edge of the fan grill and apply a little pressure to the fan grill. ↗️ **Fig. 68**

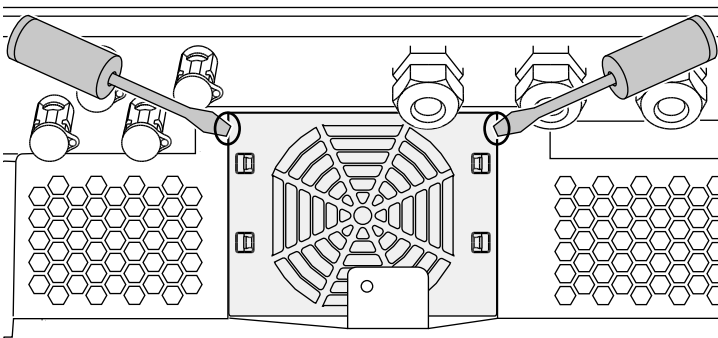

Fig. 68: Loosen fan grill

3. Press the fastening straps toward the centre of the fan with a second screwdriver.
 Pull the fan unit slightly forward. ↗️ **Fig. 69**

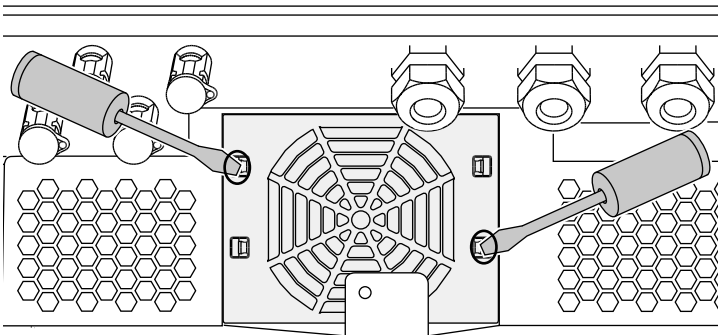

Fig. 69: Loosen fastening straps



DANGER

RISK OF DEATH DUE TO ELECTRICAL SHOCK AND DISCHARGE!

Always de-energise the device during installation and before maintenance and repairs, and secure it against being switched back on.

↗️ **Ch. 4.3 Important!** After de-energising the device, wait five minutes for the capacitors to discharge.

4. Completely remove the fan unit from the housing.
To do this, disconnect the plug of the fan cable.

 **Fig. 70**

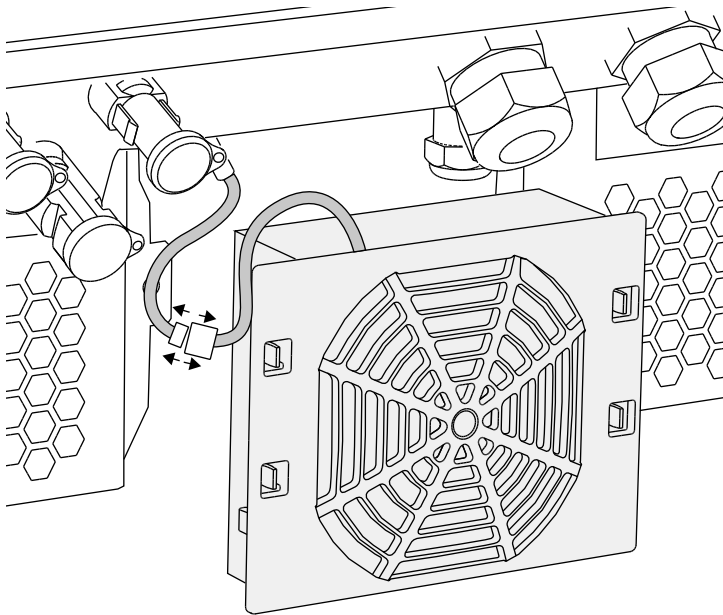



Fig. 70: Pull out fan cable

5. The fan can also be pulled off the fan grill. To do this, press the fastening straps slightly outward and pull off the fan.

 **Fig. 71**

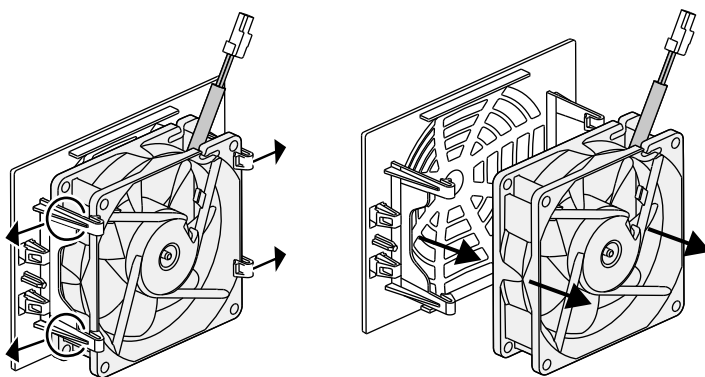



Fig. 71: Disassembly of the fan grill

6. Clean fan and housing opening with a soft brush.

7. Pay attention to the following when installing:
 - The cable must point into the housing.
 - The cable of the fan must not be pinched.
 - The fan must be correctly installed in the fan frame (air flow direction).  **Fig. 72**

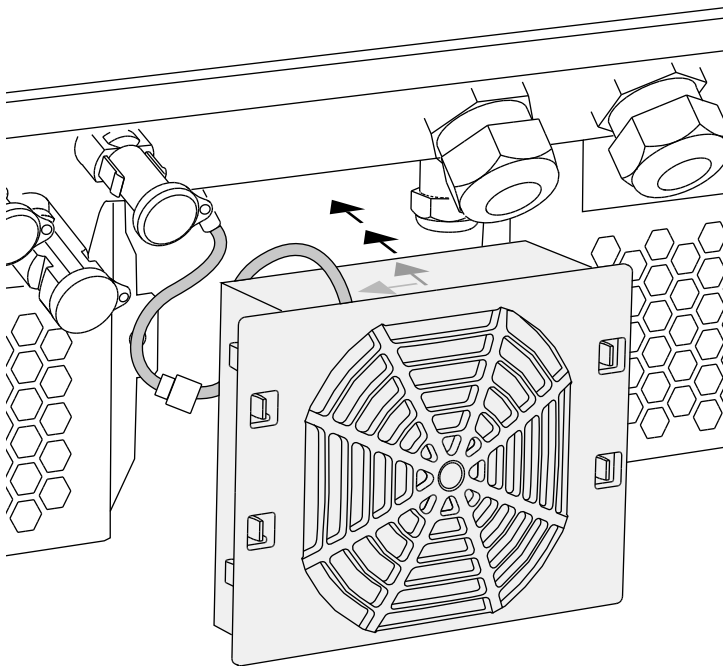





Fig. 72: Fan installation

8. Reconnect the fan cable and insert the fan into the housing. When switching on for the first time, check whether the air from the fan is drawn inwards.
9. Start up the inverter  **Ch. 4.1**

9.3 Update software (communication board)

When the communication board software is updated by the manufacturer, it can be updated on site. In the process, the software and the user interface (UI) of the communication board are brought completely up to date. If an update is available, you will find this on the manufacturer's website in the download area under PIKO Updates.

Procedure

1. Download the software update for the communication board from the manufacturer's website.
2. Go to the folder with the downloaded ZIP file.
3. Extract the ZIP file.
 - The files are extracted into a separate folder. In this folder you will find the update and important additional information on the current software update.
4. If the inverter is not yet connected with a PC via LAN, connect this with the inverter now using a LAN cable. 
 -  **Ch. 6.1**
5. Start the update by double-clicking on the *.exe file and follow the instructions of the program on the PC.
 - The update may take up to 10 minutes. Following the update, the message "Update successful" appears on the display of the inverter.
6. If the update was successful, confirm this on the inverter with the "ENTER" key.

If the update was unsuccessful, carry it out again or contact the Service team. 



IMPORTANT INFORMATION

The update results in the deletion of the inverter log data. It is therefore advisable to back this up in advance.



DANGER

RISK OF DEATH DUE TO ELECTRICAL SHOCK AND DISCHARGE!

Always de-energise the device during installation and before maintenance and repairs, and secure it against being switched back on.

 **Ch. 4.3 Important! After de-energising the device, wait five minutes for the capacitors to discharge.**



INFO



Following a successful update, the inverter automatically returns to feed-in mode.

7. Following successful installation of the software (UI), you can retrieve the current version on the inverter.
To this purpose, call up the following menu item:
Settings > Device information > SW/HW release
8. Check the time on the inverter and correct this if necessary.
To this purpose, call up the following menu item:
Settings > Basic settings > Date/time.

9.4 Update software (inverter firmware)

When the inverter firmware is updated by the manufacturer, this can be done on site. In the process, various hardware controllers are brought entirely up to date. If an update is available, you will find this on the manufacturer's website in the download area under Service.

Procedure

1. Download the software update for the inverter from the manufacturer's website.
2. Go to the folder with the downloaded ZIP file.
3. Extract the ZIP file.
- The files are extracted into a separate folder. In this folder you will find the update and important additional information on the current firmware update.
4. If the inverter is not yet connected with a PC via LAN, connect this with the inverter now using a LAN cable 
 -  **Ch. 6.1**
5. Start the update by double-clicking on the *.exe file and follow the instructions on the PC.
 - The update may take up to 30 minutes. This time is extended if the update is interrupted. Following the update, the message "Update successful" appears on the display of the inverter.
6. If the update was successful, confirm this on the inverter with the "ENTER" key. If the update was unsuccessful, carry it out again or contact the Service team. 
7. Following successful installation of the firmware (FW), you can retrieve the current version on the inverter. To this purpose, call up the following menu item: Settings > Device information > SW/HW release.



IMPORTANT INFORMATION

In order to carry out the update, enough PV energy for approx. 30 minutes must be available. The update will otherwise be interrupted or even cancelled. For this reason, only carry out the update during the day.



DANGER

RISK OF DEATH DUE TO ELECTRICAL SHOCK AND DISCHARGE!

Always de-energise the device during installation and before maintenance and repairs, and secure it against being switched back on.

 **Ch. 4.3 Important!** After de-energising the device, wait five minutes for the capacitors to discharge.



INFO



Following a successful update, the inverter automatically returns to feed-in mode.

9.5 Update software (country settings)

When the country setting of the inverter is updated by the manufacturer, this can be updated with the "Country Settings Tool". In the process, the country settings and parameters of the country currently set will be adjusted as necessary.

If an update is available, you will find this on the manufacturer's website in the download area under Service. A password may be necessary in various countries in order to activate the new parameters. The password can be acquired from the Service team.

Procedure

1. Download the current "Country Settings Tool" from the manufacturer's website.
 2. Go to the folder with the downloaded ZIP file.
 3. Extract the ZIP file.
- The files are extracted into a separate folder.
4. If the inverter is not yet connected with a PC via LAN, connect this with the inverter now using a LAN cable. 
 **Ch. 6.1**
 5. Start the update by double-clicking on the *.exe file and follow the instructions on the PC. Choose the desired setting in the application and confirm with "Activate". Please note that the country settings must have been set correctly on the inverter in advance.
 6. The inverter will restart when the update has been successful. If the update was unsuccessful, carry it out again or contact the Service team.
- ✓ The update has been carried out.



DANGER

RISK OF DEATH DUE TO ELECTRICAL SHOCK AND DISCHARGE!

Always de-energise the device during installation and before maintenance and repairs, and secure it against being switched back on.

 **Ch. 4.3 Important!** After de-energising the device, wait five minutes for the capacitors to discharge.

10. Technical data

10.1 Technical data	145
10.2 Block diagram	152

10.1 Technical data

Subject to technical changes. Errors excepted. You can find current information at www.kostal-solar-electric.com.

PIKO inverter	Unit	3.0	4.2	4.6	5.5	7.0	8.5	10	12	15	17	20
Input side												
Inverter type		PIKO	PIKO	PIKO	PIKO	PIKO	PIKO	PIKO	PIKO	PIKO	PIKO	PIKO
Max. PV power (cos φ = 1)	kWp	4.3	4.6	5.1	6.1	7.7	9.4	10.8	12.9	16.9	19.2	22.6
Rated input voltage (V _{DC,r})	V	400	680	680	680	680	680	680	680	680	680	680
Max. input voltage (V _{DCmax})	V	900	1000	1000	1000	1000	1000	1000	1000	1000	1000	1000
Max. input voltage (V _{DCmin})	V	160	160	160	160	160	160	160	160	160	160	160
Start input voltage (V _{DCstart})	V	180	180	180	180	180	180	180	180	180	180	180
Max. MPP voltage (V _{MPPmax})	V	730	800	800	800	800	800	800	800	800	800	800
Min. MPP voltage in single-tracker mode (V _{MPPmin})	V	270	400	435	530	660	–	527	626	–	–	–
Min. MPP voltage in two-tracker or parallel mode (V _{MPPmin}) ⁴	V	–	–	265	265	330	400	sym: 290/290 asym: 390/250	sym: 345/345 asym: 490/250	390	440	515
Min. MPP voltage in three-tracker mode (V _{MPPmin}) ⁴	V	–	–	–	–	–	–	–	–	sym.: 260/260/260 asym.: 325/325/250	sym.: 290/290/290 asym.: 375/375/250	sym.: 345/345/345 asym.: 450/450/250
Max. input current (I _{DCmax}) ⁴	A	12.5	11	11	11	11	11	sym.: 18/18 asym: 20/10	sym.: 18/18 asym: 20/10	sym.: 20/20/20 asym.: 20/20/10	sym.: 20/20/20 asym.: 20/20/10	sym.: 20/20/20 asym.: 20/20/10
Max. input current with parallel connection ⁶	A	–	–	22	22	22	22	36 (DC1+DC2)	36 (DC1+DC2)	40 (DC1+DC2) 20 (DC 3)	40 (DC1+DC2) 20 (DC 3)	40 (DC1+DC2) 20 (DC 3)
Max. feedback current	A	–	–	–	–	–	–	–	–	–	–	–
Number of DC inputs		1	1	2	2	2	2	2	2	3	3	3
Number of independent MPP trackers		1	1	2	2	2	2	2	2	3	3	3
Max. PV short-circuit current (I _{SC_PV})	A	18	13.8	13.8	13.8	13.8	13.8	25	25	25	25	25

PIKO inverter	Unit	3.0	4.2	4.6	5.5	7.0	8.5	10	12	15	17	20
Output side												
Rated output, $\cos \varphi = 1$ ($P_{AC,r}$)	kW	3	4.2	4.6	5.5	7	8.5	10	12	15	17	20
Max. output apparent power, $\cos \varphi_{adj}$	kVA	3	4.2	4.6	5.5	7	8.5	10	12	15	17	20
Rated output current	A	13	6.1	6.7	8	10.2	12.3	14.6	17.4	21.7	24.6	29
Max. output current (I_{ACmax})	A	13.7	6.1	6.7	8	10.2	12.5	16.2	19.3	24.2	27.4	32.2
Switch-on current (I_{inrush})	A	13.7	6.1	6.7	8	10.2	12.5	16.2	19.3	24.2	27.4	32.2
Short-circuit current (peak/RMS)	A	26.4/16.9	9.5/6.7	12.5/8.8	12.5/8.8	15.8/11.2	17.7/12.5	25/16.6	27.4/16.7	42/28.5	41.3/29.0	51/36.5
Number of feed-in phases		1	3	3	3	3	3	3	3	3	3	3
Grid connection		1N~, 230V	3N~, 400V	3N~, 400V	3N~, 400V	3N~, 400V	3N~, 400V	3N~, 400V	3N~, 400V	3N~, 400V	3N~, 400V	3N~, 400V
Rated frequency (fr)	Hz	50	50	50	50	50	50	50	50	50	50	50
Setting range of the power factor $\cos \varphi_{AC,r}$		0.9...1...0.9	0.8...1...0.8	0.8...1...0.8	0.8...1...0.8	0.8...1...0.8	0.8...1...0.8	0.8...1...0.8	0.8...1...0.8	0.8...1...0.8	0.8...1...0.8	0.8...1...0.8
Device properties												
Stand-by consumption	W	1.7	1.8	1.8	1.8	1.8	1.8	1.8	1.8	2.15	2.15	2.15
Efficiency												
Max. efficiency	%	96.2	97.5	97.7	97.7	97.6	97.6	97.7	97.7	98.0	98.0	98.0
European efficiency	%	95.5	96.1	96.3	96.3	96.5	96.5	97.1	97.1	97.2	97.3	97.3
System data												
Topology: Without galvanic separation - transformerless		✓	✓	✓	✓	✓	✓	✓	✓	✓	✓	✓
Protection type according to IEC 60529, housing/fan		IP 65/IP 55	IP 65/IP 55	IP 65/IP 55	IP 65/IP 55	IP 65/IP 55	IP 65/IP 55	IP 65/IP 55	IP 65/IP 55	IP 65/IP 55	IP 65/IP 55	IP 65/IP 55
Protective class according to IEC 62109-1		I	I	I	I	I	I	I	I	I	I	I
Overvoltage category according to IEC 60664-1 input side (PV generator) ¹		II	II	II	II	II	II	II	II	II	II	II
Overvoltage category according to IEC 60664-1 output side (grid connection) ²		III	III	III	III	III	III	III	III	III	III	III
Degree of contamination ³		4	4	4	4	4	4	4	4	4	4	4
Environmental category (outdoor installation)		✓	✓	✓	✓	✓	✓	✓	✓	✓	✓	✓
Environmental category (indoor installation)		✓	✓	✓	✓	✓	✓	✓	✓	✓	✓	✓
UV resistance		✓	✓	✓	✓	✓	✓	✓	✓	✓	✓	✓

PIKO inverter	Unit	3.0	4.2	4.6	5.5	7.0	8.5	10	12	15	17	20
Minimum cable cross-section of AC connection line	mm ²	2.5	1.5	1.5	1.5	2.5	2.5	4	4	6	6	6
Maximum cable cross-section of AC connection line	mm ²	6	6	6	6	6	6	6	6	16	16	16
Minimum cable cross-section of DC connection line	mm ²	4	4	4	4	4	4	4	4	4	4	4
Maximum cable cross-section of DC connection line	mm ²	6	6	6	6	6	6	6	6	6	6	10
Max. fusing on output side according to IEC 60898-1		B16, C16	B16, C16	B16, C16	B16, C16	B16, C16	B16, C16	B25, C25	B25, C25	B32, C32	B32, C32	B40, C40
Compatibility with external residual current protection devices		RCD type B, RCM type B										
Tightening torque of PE connection, outer	Nm	3	3	3	3	3	3	3	3	3	3	3
Tightening torque of cover screws	Nm	5	5	5	5	5	5	5	5	5	5	5
Reverse polarity protection, DC-side, with short-circuit diodes		---	---	---	---	---	---	---	---	---	---	---
Internal operator protection according to EN 62109-2		RCMU / RCCB type B										
Automatic disconnection device integrated ⁵		✓										
Height	mm (inch)	385 (15.16)	385 (15.16)	385 (15.16)	385 (15.16)	385 (15.16)	385 (15.16)	445 (17.52)	445 (17.52)	540 (21.26)	540 (21.26)	540 (21.26)
Width	mm (inch)	500 (19.69)	500 (19.69)	500 (19.69)	500 (19.69)	500 (19.69)	500 (19.69)	580 (22.83)	580 (22.83)	700 (27.56)	700 (27.56)	700 (27.56)
Depth	mm (inch)	222 (8.74)	236 (9.29)	236 (9.29)	236 (9.29)	236 (9.29)	236 (9.29)	248 (9.76)	248 (9.76)	265 (10.43)	265 (10.43)	265 (10.43)
Weight	kg (lb)	22 (48.50)	24 (52.91)	25.5 (56.22)	25.5 (56.22)	26.5 (58.42)	26.5 (58.42)	37.5 (82.67)	37.5 (82.67)	48.5 (106.92)	48.5 (106.92)	48.5 (106.92)
Cooling principle - convection		✓	✓	–	–	–	–	–	–	–	–	–
Cooling principle - regulated fans		–	–	✓	✓	✓	✓	✓	✓	✓	✓	✓
Max. air throughput	m ³ /h	–	–	84	84	84	84	2x48	2x48	2x84	2x84	2x84
Max. noise emission	dBA	<33	43	52	52	52	52	43	44	56	56	56
Ambient temperature	°C (°F)	-20 ... 60 (-4 ... 140)										
Max. operating altitude above sea level	m (ft)	2000 (6562)	2000 (6562)	2000 (6562)	2000 (6562)	2000 (6562)	2000 (6562)	2000 (6562)	2000 (6562)	2000 (6562)	2000 (6562)	2000 (6562)
Relative humidity (condensing)	%	4 ... 100	4 ... 100	4 ... 100	4 ... 100	4 ... 100	4 ... 100	4 ... 100	4 ... 100	4 ... 100	4 ... 100	4 ... 100
Connection technology on input side		MC 4	MC 4	MC 4	MC 4	MC 4	MC 4	SUNCLIX	SUNCLIX	SUNCLIX	SUNCLIX	SUNCLIX
Connection technology on output side - spring-loaded terminal strip		✓	✓	✓	✓	✓	✓	✓	✓	✓	✓	✓

PIKO inverter	Unit	3.0	4.2	4.6	5.5	7.0	8.5	10	12	15	17	20
Interfaces												
Ethernet RJ45		2	2	2	2	2	2	2	2	2	2	2
RS485		1	1	1	1	1	1	1	1	1	1	1
S0-Bus		1	1	1	1	1	1	1	1	1	1	1
Analog inputs		4	4	4	4	4	4	4	4	4	4	4
PIKO BA Sensor interface		–	1	1	1	1	1	1	1	1	1	1
PIKO BA Sensor												
Primary rated current (peak/RMS)	A	–	50/35	50/35	50/35	50/35	50/35	50/35	50/35	50/35	50/35	50/35
Secondary rated current	A	–	1	1	1	1	1	1	1	1	1	1
Ext. current sensor transmission ratio		–	50:1	50:1	50:1	50:1	50:1	50:1	50:1	50:1	50:1	50:1
Accuracy class		–	1	1	1	1	1	1	1	1	1	1
Connected power	KW	–	27	27	27	27	27	34.5	34.5	34.5	34.5	34.5
Dimensions (H x W x D)	mm (inch)	–	90 x 105 x 54 (3.5 x 4.1 x 2.1)	90 x 105 x 54 (3.5 x 4.1 x 2.1)	90 x 105 x 54 (3.5 x 4.1 x 2.1)	90 x 105 x 54 (3.5 x 4.1 x 2.1)	90 x 105 x 54 (3.5 x 4.1 x 2.1)	90 x 105 x 54 (3.5 x 4.1 x 2.1)	90 x 105 x 54 (3.5 x 4.1 x 2.1)	90 x 105 x 54 (3.5 x 4.1 x 2.1)	90 x 105 x 54 (3.5 x 4.1 x 2.1)	90 x 105 x 54 (3.5 x 4.1 x 2.1)
Max. line diameter	mm (inch)	–	13.5 (0.5)	13.5 (0.5)	13.5 (0.5)	13.5 (0.5)	13.5 (0.5)	13.5 (0.5)	13.5 (0.5)	13.5 (0.5)	13.5 (0.5)	13.5 (0.5)
Installation on top-hat rail according to EN 60715		–	TH35	TH35	TH35	TH35	TH35	TH35	TH35	TH35	TH35	TH35

¹ Overvoltage category II (DC input) The device is suitable for connection to PV strings. Long feed cables out of doors or a lightning protection system in the vicinity of the PV system may make lightning protection or surge protection equipment necessary.

² Overvoltage category III (AC output): The device is suitable for permanent connection in the grid distribution behind the meter and the line protection fuse. When the connection line travels outdoors over long distances, overvoltage protection devices may be necessary.

³ Contamination degree 4: Contamination results in continuous conductivity, e.g. due to conductive dust, rain or snow; indoors or outdoors.

⁴ In the case of symmetrical DC feed-in, strings of the same length are connected to the inverter. In the case of unsymmetrical DC feed-in, strings of varying lengths are connected to the inverter.

⁵ Disconnection device to VDE V 0126-1-1, for Austria: The inverter is equipped "With automatic disconnection device in accordance with ÖVE/ÖNORM E 8001-4-712".

⁶ It is essential to ensure that with parallel connection the maximum current load of the DC plugs is not exceeded (max. 30 A). This could result in damage to the device. If the DC string input current is higher than the maximum plug load (see manufacturer's information), both DC inputs should be used.

10.2 Block diagram

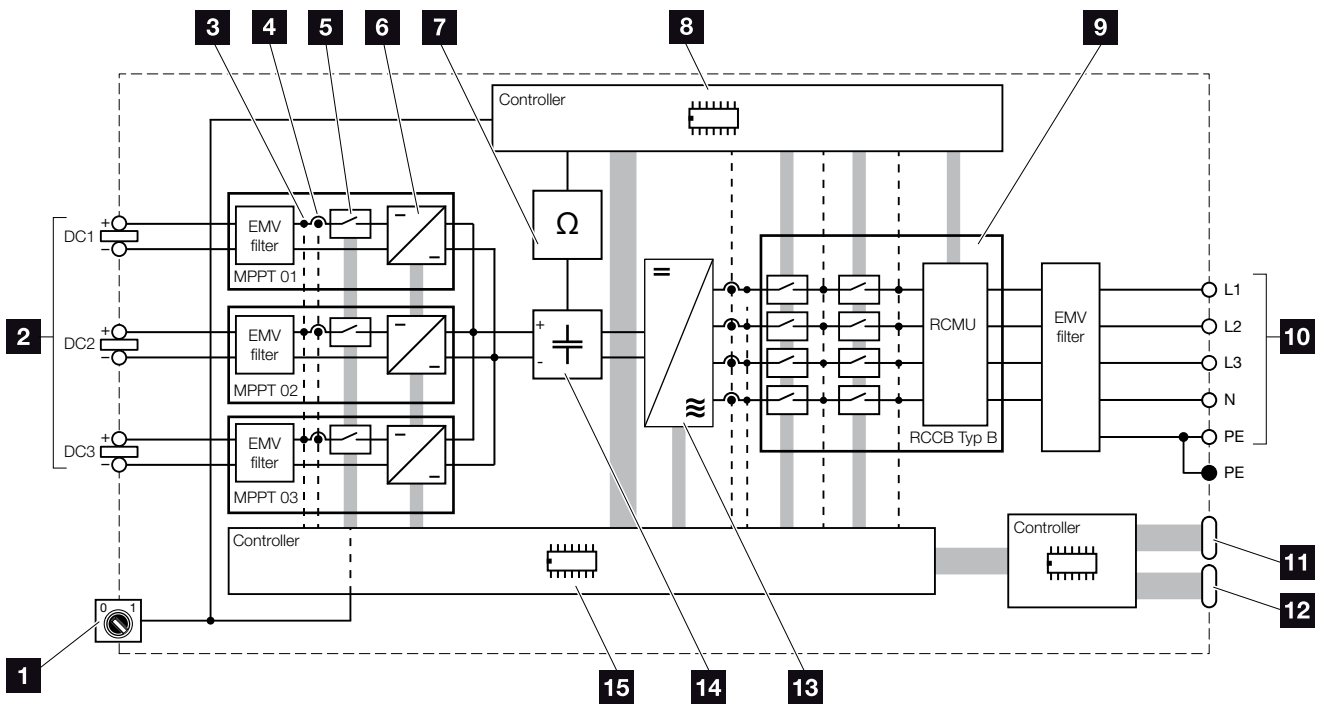

Fig. 73: Block diagram

- 1** DC switch
- 2** PV string (number depends on the type)
- 3** Voltage measuring point
- 4** Current measuring point
- 5** Electronic DC switch
- 6** DC regulator
- 7** Insulation monitoring
- 8** Grid monitoring and shut-down system control
- 9** Grid monitoring and shut-down
- 10** 1-phase or 3-phase AC output (phases depend on the type)
- 11** Display and communication
- 12** PIKO BA Sensor interface (depending on type)
- 13** Inverter bridge
- 14** Intermediate circuit
- 15** System control with MPP trackers

11. Accessories

11.1 Installation of PIKO BA Sensor	154
11.2 Operating the system with multiple inverters and PIKO BA Sensor	158
11.3 Additional accessories	161

11.1 Installation of PIKO BA Sensor

The PIKO BA Sensor is used to optimally record and control the energy flow in the building. The control and distribution of energy between the DC side (solar generator) and the AC side (building grid, public grid) is thereby carried out by the energy management system (EMS). To this purpose, the EMS uses the PIKO BA Sensor to check for the presence of consumption in the internal home network. The logic of the EMS then uses this to calculate and control the optimal usage of PV energy.

The generated PV energy is primarily used for consumers (such as light, washing machine or television). The energy generated beyond this is fed into the public grid.

Product features of the PIKO BA Sensor:

- Registration of home consumption with analogue current measurement
- Easy installation due to assembly on top-hat rail according to EN 60715
- Control of inverter output according to the principle of dynamic active power control.

You can find additional information about this product on our website www.kostal-solar-electric.com under the category Products/Monitoring.

Installation and connection of the PIKO BA Sensor

The PIKO BA Sensor is used to record the self-consumption of the building or the power fed into the grid, and to represent it in the solar portal.

In addition to this, the sensor can also be used with smaller systems up to 30KW for which a permanent reduction, for example, to 70 % has been set as an affordable alternative to the ripple control receiver.

In combination with the sensor, the inverter can carry out dynamic self-consumption regulation, and thus optimally distribute the generated energy.



IMPORTANT INFORMATION

The current sensor can be used as of firmware version 05.00.

The various modes of the current sensor position are set via the menu in the inverter. The choice of the current sensor position depends on the hardware/firmware/user interface version of the inverter and not all positions may be available.

Mode 1 possible with firmware version 05.00 and higher

Mode 2 possible with firmware version 05.35 and higher

Before installing the PIKO BA Sensor, check by referring to the hardware/firmware version on the type plate or in the inverter menu > Current sensor position which positions are possible with your inverter.

Only one sensor can be operated per PV system. The consumption of several inverters cannot be measured using a PIKO BA Sensor.

To record home consumption, the PIKO BA Sensor needs PV energy. If the PV energy generated is lower than $V_{DCstart}$ home consumption can no longer be recorded.

In the case of the PIKO 3.0 it is not possible to connect a PIKO BA Sensor.

The sensor is installed on a top-hat rail in the meter box or the main distributor.

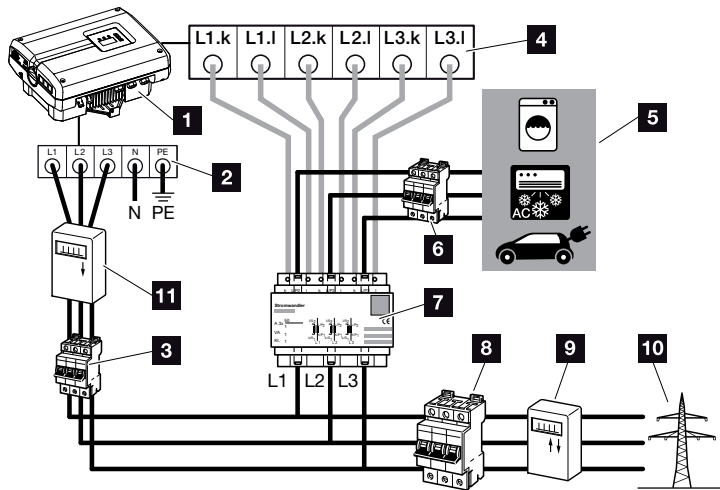



Fig. 74: **Mode 1** Recording home consumption data 



INFO

In Mode 1 home consumption, the sensor measures the power consumption of all consumers in the house and calculates the current which is fed into the public grid.

In Mode 2 grid feed-in, the sensor measures the current which is fed into the public grid and calculates the power consumption of all consumers and the inverter in the house.

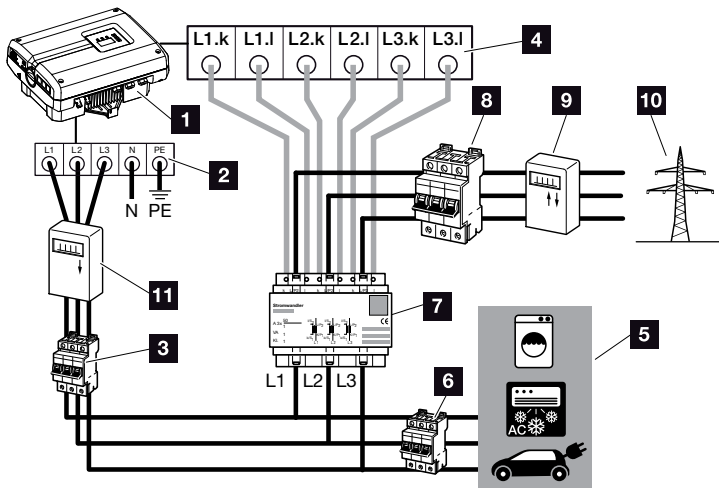

Fig. 75: **Mode 2** Recording grid feed-in

- 1** PIKO inverter
- 2** AC terminal in the inverter
- 3** Line circuit breaker for inverter
- 4** Terminal for current sensor in the inverter
- 5** Energy consumers
- 6** Line circuit breaker for energy consumers
- 7** PIKO BA Sensor
- 8** Line circuit breaker for house
- 9** Feed-in procurement meter
- 10** Public grid
- 11** PV meter (as of PV systems with >10 kWp total output)

Procedure

1. De-energise the inverter. ⚠
🔗 Ch. 4.3
2. Mount the PIKO BA Sensor on the top-hat rail of an electrical cabinet or power distributor. Only the sensor approved for the inverter may be used.
3. Open the inverter cover.
4. Depending upon the mode, properly lay the cable from the inverter into the electrical cabinet.
🔗 Fig. 74, Fig. 75 !
5. Connect the 6-conductor cable of the inverter according to the wiring diagram.
 The 6-conductor control cable from the inverter to the PIKO BA Sensor must have a wire cross-section of 0.75mm^2 to 2.5mm^2 and a maximum length of 20 m. The wire stripping length is 8-9 mm.

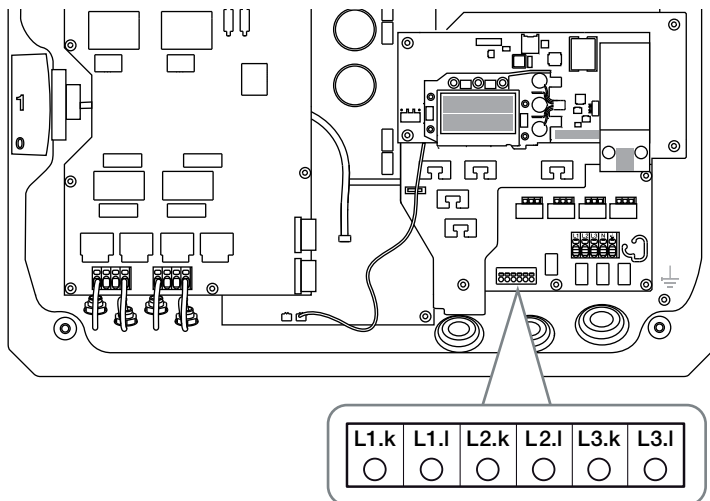

Fig. 76: Sensor terminal

6. Install the cover and screw it tight (5 Nm).
7. Switch on the inverter 🔗 Ch. 4.1



DANGER

RISK OF DEATH DUE TO ELECTRICAL SHOCK AND DISCHARGE!

De-energise the device, secure it against being restarted and wait five minutes so that the capacitors can discharge. 🔗 Ch. 4.3



IMPORTANT INFORMATION

When carrying out the three phases through the PIKO BA Sensor, it is imperative that the following points are observed to avoid incorrect measurements:

- It must be ensured that the phases of the AC terminal (L1, L2 and L3) and the PIKO BA Sensor are assigned uniformly. Otherwise incorrect measurements may result.
- Ensure that the PIKO BA Sensor is installed in the correct location depending on the modes in your home network. An incorrectly installed or wired PIKO BA Sensor does not provide correct data.

8. Activate the current sensor in the menu of the inverter.  **Ch. 4.7** 

To this purpose, select the corresponding mode in the "Current sensor position" menu.

Mode: without sensor

No current sensor installed

Mode: 1

Current sensor position for measuring home consumption (standard setting)

Mode: 2

Current sensor position for measuring grid feed-in

- ✓ The PIKO BA Sensor is connected.



**IMPORTANT
INFORMATION**

The position (mode) of the PIKO BA Sensor can be set via the menu in the inverter. Depending on the version of the inverter's software and hardware this may differ and not all positions may always be available.

11.2 Operating the system with multiple inverters and PIKO BA Sensor

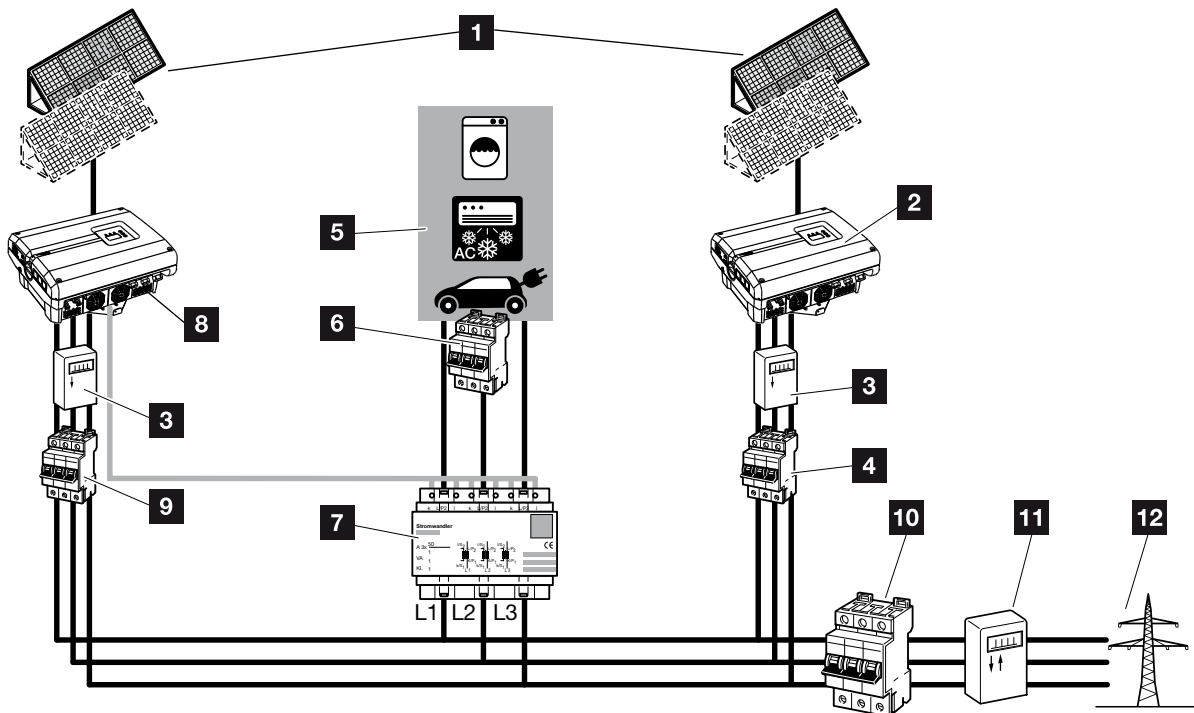

Fig. 77: Connection of several inverters - current sensor position mode 1 - home consumption data (possible as of PIKO 4.2)

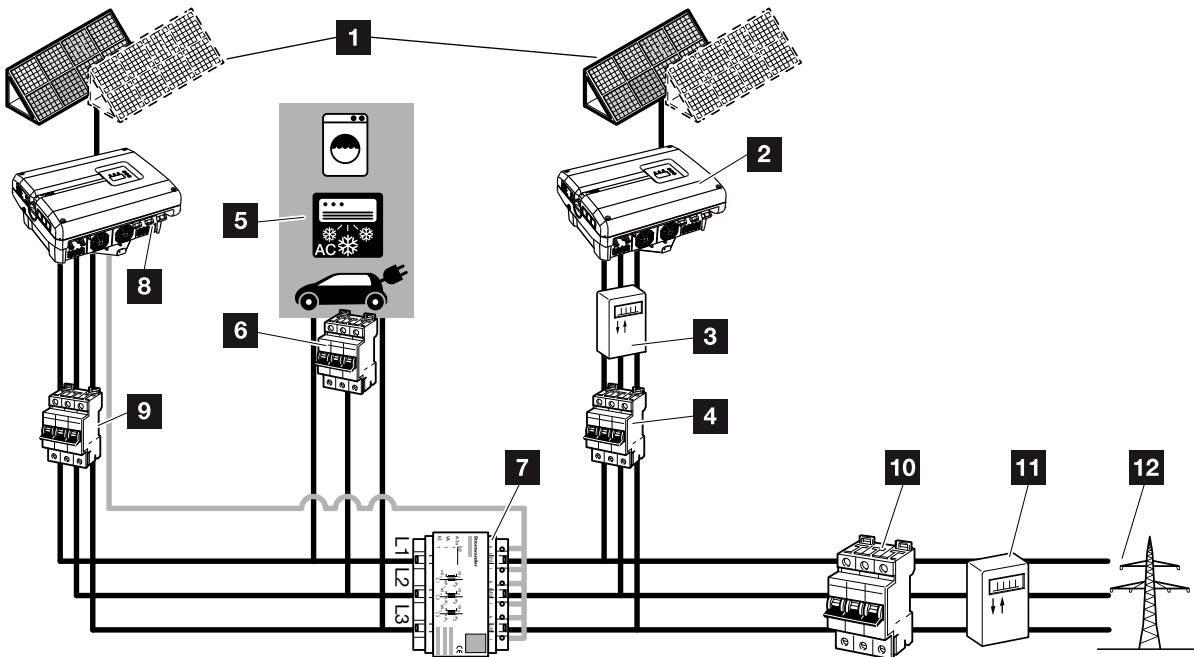

Fig. 78: Connection of several inverters - current sensor position mode 2 - grid consumption data (possible as of PIKO 4.2)

- 1 PV generators
- 2 Inverters without connected sensors (also external devices)
- 3 PV meter for inverter (required as of PV systems with >10 kWp total output)
- 4 Line circuit breaker for inverter
- 5 Energy consumers
- 6 Line circuit breaker for energy consumers
- 7 PIKO BA Sensor
- 8 PIKO inverter with sensor connection
- 9 Line circuit breaker for PIKO inverter
- 10 Line circuit breaker for house
- 11 Feed-in procurement meter
- 12 Public grid

In addition to the PIKO inverter, other inverters can also be used in a photovoltaic system.

Ensure that all inverters in the home network fulfil the VDE-AR-N 4105 standard. ⚠

The inverters can be wired in different variants and modes.

Ensure that no cross-connection occurs when the PV generators are connected. ⚠

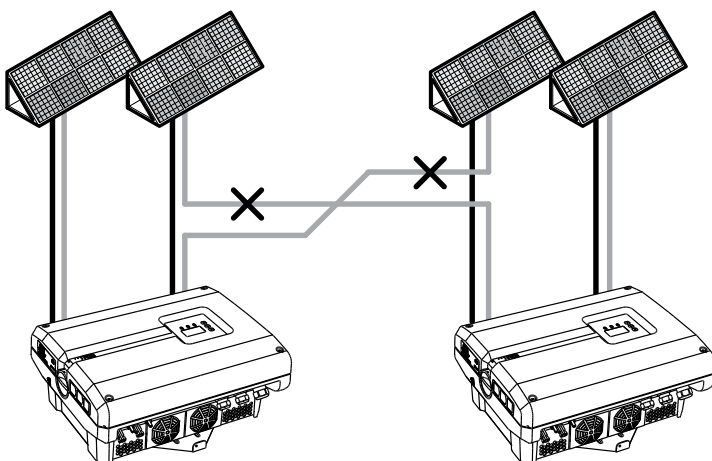

Fig. 79: Incorrect connection of PV generators







IMPORTANT INFORMATION

Only the yield of the PIKO inverter can be represented in a system with several inverters without additional measures.



DAMAGE POSSIBLE

If the PV generators are incorrectly connected, the inverters may be damaged. Check the connections before commissioning.

1. De-energise the home network and inverter
 **Ch. 4.3** 
 2. Integrate inverters into the system as shown in the diagrams  **Fig. 77, Fig. 78** and connect them properly 
- ✓ Inverter is connected.

Only the yield of the PIKO inverter can be represented in a system with several inverters without additional measures.

**DANGER**

RISK OF DEATH DUE TO ELECTRICAL SHOCK AND DISCHARGE!

De-energise the device, secure it against being restarted and wait five minutes so that the capacitors can discharge.  **Ch. 4.3**

**IMPORTANT INFORMATION**

It must be ensured that the assignment of the phases of the AC terminal (L1, L2, L3) of the additional inverter harmonises with the phases of the PIKO BA sensor.

11.3 Additional accessories

PIKO M2M Service

The PIKO M2M Service allows KOSTAL customers to monitor a PV system using a mobile link to the PIKO Solar Portal for continuous system monitoring.

A secure and encoded VPN connection which only allows communication between PIKO inverters and the PIKO Solar Portal protects the user against misuse and excessive costs.

The 5-year package price involves no monthly costs, reducing administration and assuring smooth monitoring for a period of at least five years. Two different packages are available depending on the size of the system.

You can find additional information about this product on our website www.kostal-solar-electric.com under the category Products/Monitoring.

PIKO Solar Portal

The PIKO Solar Portal makes it possible to monitor the operation of the PIKO inverters via the Internet. Registration for the PIKO Solar Portal takes place at no charge on our website.

The portal code for the PIKO Solar Portal (www.piko-solar-portal.de) is P3421.

You can find additional information about this product on our website www.kostal-solar-electric.com under the category Products/Monitoring.

PIKO Solar App

Using the new PIKO Solar App, customers can monitor their systems easily via their smartphone or tablet. Important data relating to the PV system can be queried using the app. For example, you can monitor your DC yield and see how much electricity you're feeding into the public grid. If you have a PIKO inverter to which a PIKO BA Sensor is also connected, you will also be able to see the home consumption. With the PIKO BA system, you can even see how much of the electricity you are producing is being fed into the battery, or being used from the battery. In addition to this live data, which is updated via WLAN, you can also display past yields, e.g. from yesterday or last week, as a diagram.

You can find additional information about this product on our website www.kostal-solar-electric.com under the category Products/Monitoring - Accessories.

PIKO Sensor

The PIKO Sensor makes it possible to compare the real irradiation and temperature conditions with the performance data of the PV system.

The following values are measured with the PIKO Sensor:

- Irradiation
- Ambient temperature
- Module temperature

A special feature: The measuring values can be visualised via a solar portal (e.g. PIKO Solar Portal).

You can find additional information about this product on our website www.kostal-solar-electric.com under the category Products/Monitoring.

12. Appendix

12.1 Type plate	165
12.2 Warranty and service	166
12.3 Handover to the operator	167
12.4 Disassembly and disposal	168

12.1 Type plate

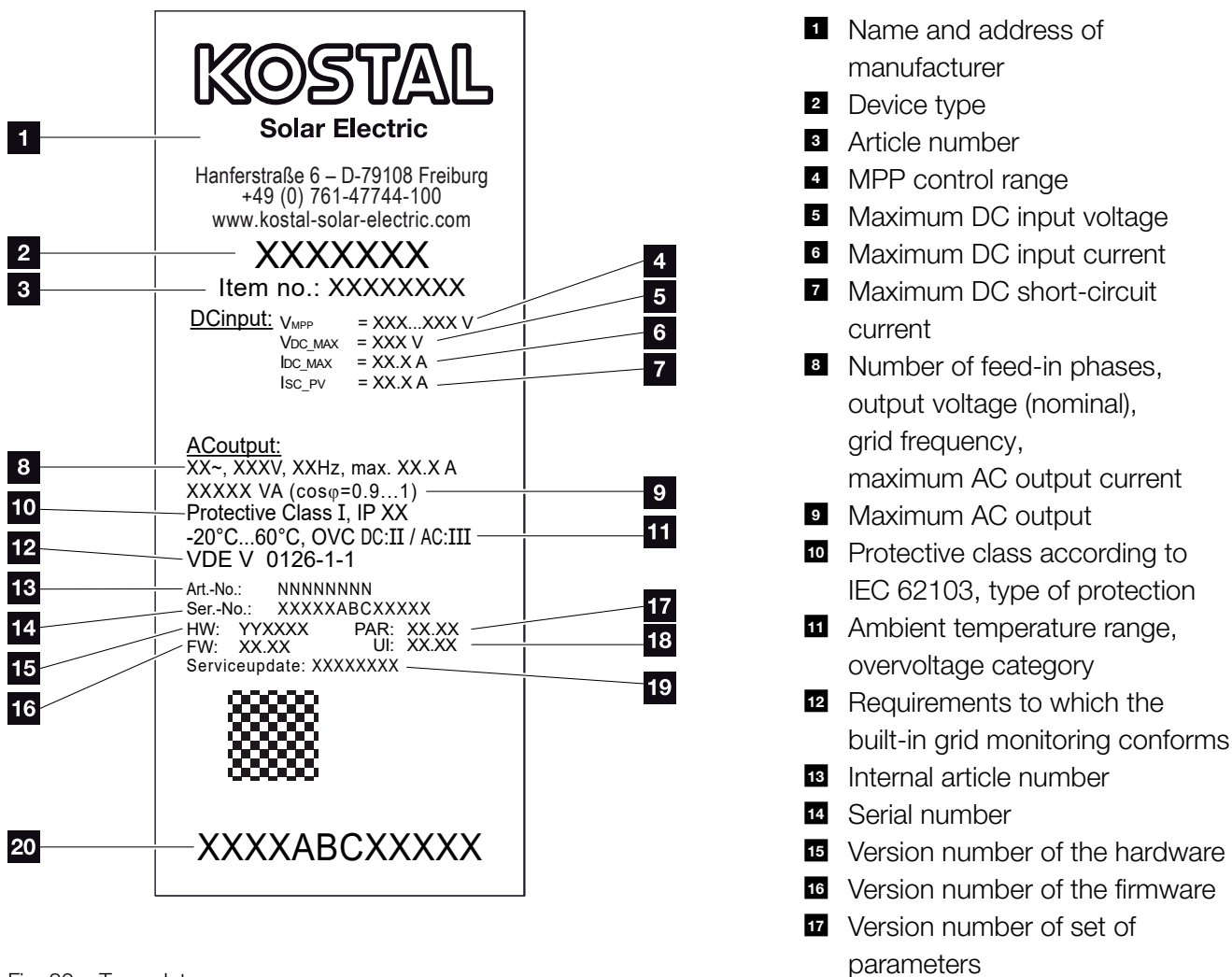

Fig. 80: Type plate

The type plate is located on the right hand side of the inverter. You will find the device type and the most important technical data listed on the type plate.

- 1** Name and address of manufacturer
- 2** Device type
- 3** Article number
- 4** MPP control range
- 5** Maximum DC input voltage
- 6** Maximum DC input current
- 7** Maximum DC short-circuit current
- 8** Number of feed-in phases, output voltage (nominal), grid frequency, maximum AC output current
- 9** Maximum AC output
- 10** Protective class according to IEC 62103, type of protection
- 11** Ambient temperature range, overvoltage category
- 12** Requirements to which the built-in grid monitoring conforms
- 13** Internal article number
- 14** Serial number
- 15** Version number of the hardware
- 16** Version number of the firmware
- 17** Version number of set of parameters
- 18** Version number of the user interface of the device
- 19** Date of last update (only for service devices)
- 20** Removable warranty label

12.2 Warranty and service

- Information on the warranty can be found in the warranty conditions, which are included separately.
- For service information and a possible subsequent shipment of parts, we require your device type and the serial number. You will find this information on the type plate on the exterior of the housing.
- If parts are required, use only original replacement parts.

If you have any technical questions, please call our service hotline:

- Germany and other countries¹
+49 (0)761 477 44 - 222
- Switzerland
+41 32 5800 225
- France, Belgium, Luxembourg
+33 16138 4117
- Greece
+30 2310 477 555
- Italy
+39 011 97 82 420
- Spain, Portugal²
+34 961 824 927
- Turkey³
+90 212 803 06 26

¹ Language: German, English

² Language: Spanish, English

³ Language: English, Turkish



12.3 Handover to the operator

Following successful installation and commissioning, all documents are to be handed over to the operator. The attention of the operator must be drawn to the following points:

- Position and function of the DC switch
- Position and function of the AC line circuit breaker
- Safety when handling the device
- Appropriate procedure when checking and servicing the unit
- Meaning of the LEDs and the display messages
- Contact person in the event of a fault

12.4 Disassembly and disposal

To disassemble the inverter, proceed as follows:

1. De-energise the inverter.
 **Ch. 4.3** 
2. Open the inverter cover.
3. Loosen terminals and cable screw connections.
4. Remove all DC and AC lines.
5. Close the inverter cover.
6. Loosen the screw underneath the inverter.
7. Lift the inverter from the wall mount.
8. Dismantle the wall mount.

Proper disposal

Electronic equipment labelled with a dustbin with a line through it, may not be disposed of with household waste. This equipment can be handed in to waste collection points free of charge.



Find out about the local requirements for the separate collection of electrical and electronic equipment in your country.



DANGER

RISK OF DEATH DUE TO ELECTRICAL SHOCK AND DISCHARGE!

De-energise the device, secure it against being restarted and wait five minutes so that the capacitors can discharge.  **Ch. 4.3**



Index

A

Accessories.....	153
Active power control.....	117, 122
Alarm output.....	56
Auto IP	74, 100, 109

B

Block diagram	152
---------------------	-----

C

Cable.....	151
Call up Webserver	89
Communication board	33, 55, 75
Connect computer	89
Control buttons.....	34
Country setting.....	76
Current operating manual	11

D

Data export	74, 113, 114, 115
DC cables	50, 54, 168
DC connections.....	47, 65
DC switch.....	27, 59, 63, 64, 65, 152
DHCP server	100, 109
Display	45, 59, 66, 67, 68, 69, 71, 78
Disposal	168
Dynamic self-consumption control.....	127

E

EMS	77
Energy management system	77
Ethernet.....	58, 89, 90, 100, 108, 120, 121, 151
Ethernet cable	89, 90, 121, 122, 127
Event codes	78
Event messages	34, 75
External module control	38, 103

**F**

Factory setting.....	76
Faults	75, 112
Firmware	165
Function of the inverter	51

G

Grid monitoring.....	79, 112, 165
----------------------	--------------

H

History.....	93, 163
Hotline.....	7, 166

I

Initial commissioning.....	59
Inputs.....	51, 52, 57, 145, 151
Interfaces.....	57, 58, 151
IP address	74, 88, 89, 100, 109, 122, 127

L

LAN.....	58, 88
Language	2, 74
Line circuit breaker	47, 59, 63, 65
Log data.....	90, 98, 110, 112, 113

M

Menu.....	35, 52, 60, 67, 71, 72, 74
Modem.....	101

N

Name of the inverter	89
Network settings	122
Notes	11, 13, 16

O

Open the inverter cover	89, 90, 168
Operation	67
Operational statuses.....	34, 69



P

Parallel connection.....	43, 51, 103, 145, 150
Password	90
Plant configuration.....	103
Plant management	103
Proper use.....	8
Proxy server	88
PV generator	79, 147

R

Recording home consumption.....	39, 154
Renewable Energies Act.....	117, 118
Reset web login.....	76
Ripple control receiver	57, 99, 120, 121, 122
RJ45	33, 58, 89, 121, 151
Router	58, 74
RS485.....	57, 74, 100, 120, 151

S

S0 interface	96
Safety instructions	13
Saving interval	37, 102
Scope of delivery.....	42
Sealing cap	42
Self-consumption	8, 35, 56, 71, 73, 104, 112, 124, 125, 127, 128, 129, 130, 131, 132
Self-consumption control.....	104, 126, 127, 128
Sensor.....	57, 99, 163
Service menu	76
Settings	34, 35, 37, 39, 52, 56, 66, 71, 74, 88, 89, 90, 99, 107, 114, 122, 126
Shadow management	38, 103
Solar portal.....	113, 163
Spring-loaded terminal strips	49
Storage	41
Strings.....	53, 59, 63, 64, 112
Switched output	56, 125, 126
System with several inverters.....	159

**T**

Technical data	125, 145
Terminal.....	48, 56, 57, 121, 124, 125, 156
Transport	41
Type plate.....	78, 89, 122, 165, 166

U

User name.....	90, 122
----------------	---------

W

Wall mount	42, 46, 168
Warnings	14
Warranty.....	9, 50, 166
Webserver	36, 56, 87, 88, 89, 99, 107, 108, 122, 126, 127

KOSTAL

KOSTAL Solar Electric GmbH
Hanferstr. 6
79108 Freiburg i. Br.
Deutschland
Telefon: +49 761 47744 - 100
Fax: +49 761 47744 - 111

KOSTAL Solar Electric Ibérica S.L.
Edificio abm
Ronda Narciso Monturiol y Estarriol, 3
Torre B, despachos 2 y 3
Parque Tecnológico de Valencia
46980 Valencia
España
Teléfono: +34 961 824 - 934
Fax: +34 961 824 - 931

KOSTAL Solar Electric France SARL
11, rue Jacques Cartier
78280 Guyancourt
France
Téléphone: +33 1 61 38 - 4117
Fax: +33 1 61 38 - 3940

KOSTAL Solar Electric Hellas E.Π.Ε.
47 Steliou Kazantzidi st., P.O. Box: 60080
1st building – 2nd entrance
55535, Pilea, Thessaloniki
Ελλάδα
Τηλέφωνο: +30 2310 477 - 550
Φαξ: +30 2310 477 - 551

KOSTAL Solar Electric Italia Srl
Via Genova, 57
10098 Rivoli (TO)
Italia
Telefono: +39 011 97 82 - 420
Fax: +39 011 97 82 - 432

KOSTAL Solar Electric Turkey
Mahmutbey Mah. Taşocağı Yolu
No:3 (B Blok), Ağaoğlu My Office212,
Kat:16, Ofis No: 269
Güneşli-İstanbul
Türkiye
Telefon: +90 212 803 06 24
Faks: +90 212 803 06 25