



BYD Battery-Box Premium HVS/HVM

Service Guideline and Checklist

Version 1.5

Valid for HVS 5.1 / 7.7 / 10.2 / 12.8
HVM 8.3 / 11.0 / 13.8 / 16.6 / 19.3 / 22.1

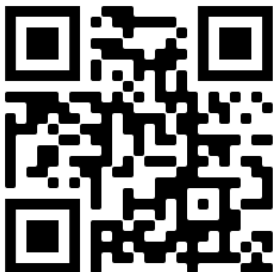

Make sure to always use the latest version of this service document,
available at: www.bydbatterybox.com

Important: The installation and all other kinds of works or measurements in combination with the Battery-Box Premium are only allowed by professional and qualified electricians.

This checklist is a shortened assistance for the Battery-Box and does not replace the original manual, which can be found on www.bydbatterybox.com / www.eft-systems.de / www.alpspower.com.au. Subject to technical modifications; no responsibility is accepted for the accuracy of this information. Attention: High Voltage! Improper handling can cause danger and damage.

CONTENT

CONTENT	2
1. GENERAL STEPS	3
2. ERROR ANALYSIS	4
2.1 BCU shows no reaction / No LED	4
2.2 BCU switch cannot be pulled up / LED remains on	4
2.3 Problem with the Firmware Update / App Configuration / Battery WiFi	5
2.4 Battery <-> inverter communication / no charging or discharging	6
2.5 SOC & charging logic	7
2.6 Unexpected shutdown	7
2.7 Module Extension / Parallel connection	8
2.8 Be Connect Plus (BCP)	9
2.9 LED event code (EC)	10
2.10 Voltage measurement and undervoltage	13
2.11 Identifying a faulty module / Module exclusion method	14
3. SERVICE TASKS	15
3.1 BCU replacement	15
3.2 Module Replacement	15
SERVICE CHECKLIST AND CONTACT INFORMATION	16

1. GENERAL STEPS

Make sure to always use the latest version of this service document, available at: www.bydbatterybox.com

Please proceed first with the installation steps by:

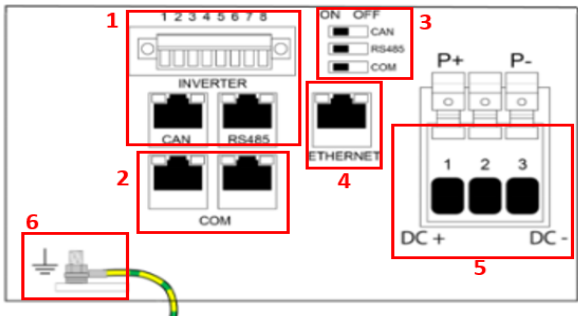
No.	Name	Description
1	Configuration	Check if the configuration is correct. Refer to latest "BYD Battery-Box Premium HVS & HVM Compatible Inverter List" (V1.8 or above) available at: www.bydbatterybox.com Make sure the inverter is configured correctly.
2	Only HVS or HVM	Do not mix up HVS-modules ("I") with HVM-modules ("II").
3	External connections	 <ol style="list-style-type: none"> 1. Communication to inverter 2. Ports for parallel connection 3. Dip-Switches 4. Ethernet-Cable for Internet (strongly recommended!) 5. DC-Ports 6. Grounding
4	Closed Connection Area	The Connection Area must be closed in order to start the system (else the system switch will immediately shut off!)
5	Latest Firmware	Always install / update the newest Firmware! (also use the latest App Version!) Note: If not stated otherwise, the Wi-Fi password is BYDB-Box
6	App Configuration	To complete the commissioning, the configuration of the battery via "BYD Be Connect" App or "BYD Be Connect Plus" (BCP) Tool for PC is mandatory!
7	Proper Restart	<p>NOTE: It is important that the battery is switched on before the inverter! Else, the BCU might not start and not show any reaction (no LED, no WiFi)</p> <p>Defined restart (mind the sequence)</p> <ol style="list-style-type: none"> 1) Switch off Battery (press power button for 5 seconds)* 2) Turn off DC switch of the inverter 3) Turn off AC switch 4) Kostal only: Pull out the PV strings from inverter 5) wait 10 minutes 6) Turn on the battery (switch up) 7) Kostal only: Connect PV strings back to inverter 8) Turn on the AC switch 9) Turn on the DC switch on the inverter <p>*if the battery does not switch off despite pressing the LED for 5 seconds, lift off the BCU to avoid further discharge and contact the service.</p>
8	Checking the correct operation	<p>The system runs properly if:</p> <ul style="list-style-type: none"> - Inverter displays battery SOC correctly - System charges / discharges <p>Note: If you can not complete the commissioning, then turn off the battery before you leave the site and make sure all LEDs are off. If this is not possible, remove the BCU. Make sure the system will be set into operation quickly.</p>

2. ERROR ANALYSIS

2.1 BCU shows no reaction / No LED

LEDs do not light up, although the system switch is ON.

No.	Name	Description
9	Module quantity	Check if the module quantity fulfills the minimum requirement (HVS: 2, HVM: 3 modules) and check the "Compatible Inverter List" for inverter requirements.
10	Voltage measurement	See section 2.10
11	Use correct turn on procedure	NOTE: It is important that the battery is switched on <u>before</u> the inverter! Else, the BCU might not start and not show any reaction (no LED, no WiFi). See following: 1) Switch off Battery (press power button for 5 seconds) 2) Turn off DC switch of the inverter 3) Turn off AC switch 4) Kostal only: Pull out the PV strings from inverter 5) Lift BCU (disconnect from modules) and put it back after 5 min (inverter should be off) 6) Turn on the battery (switch up) → LED should light up again 7) Kostal only: Connect PV strings back to inverter 8) Turn on the AC switch 9) Turn on the DC switch on the inverter
12	Only LED off?	Check if there is a wifi access point of the Battery-Box. If so, only the external LED is inactive and a commissioning could still work. In that case make sure that the internal cable of the LED is connected properly.
13	BCU exchange	Only if cover is closed and voltage look good: Test another BCU, if available.

2.2 BCU switch cannot be pulled up / LED remains on

The system switch switches off immediately (within 5 seconds) / LED remains on eventhough system switch is down

No.	Name	Description
14	Close the cover	Make sure the cover for the connection area on the BCU is properly closed. Important: If the panel is open, the battery won't turn on (for safety reasons)
15	Switch was pulled down by hand	If the switch was pulled down manually, then it cannot be pushed up again within 10 minutes. (Please refer to the manual for the correct switch off procedure)
16	Solid blue LED? EC102? (1xwhite, 2xblue)	Try to properly shut down the BCU (press the LED power button for more than 5 Sec.) - If LED goes off: Check the DC cable installation, make sure that battery configuration via app / BCP has been done correctly (e.g module type and quantity) and that there are no faults in the app / BCP. Restart system properly (see step 7) - If the LED remains on (solid blue or 2xblue blinking): Remove the BCU from the tower to avoid a deep discharge. Measure the voltage of the system (see section 2.10) and contact your service partner. You can use another BCU, if available.
17	BCU exchange	Only if the cover is closed and voltage looks good: Test another BCU, if available.

2.3 Problem with the Firmware Update / App Configuration / Battery WiFi

The BCU consists of two components: the BMU and the BMS. The Firmware Update from the App will update the BMU, which will then update the BMS. **The BMS will only be updated once there is communication between the battery and the inverter or just after the App configuration. It can take up to 20 Minutes until the firmware is updated on the BMS.**

No	Name	Description
18	Correct App and Firmware	<p>Make sure to have the latest App Version (>1.7.4) and Battery Firmware (download inside the App) on your mobile device before connecting the app with the battery Wi-Fi.</p> <p>If the App cannot be installed, or other general Problems occur with the App:</p> <ul style="list-style-type: none">- try with a different mobile device- Deinstall and reinstall the App- or try with PC Tool BCP (section 2.8).
19	WiFi cannot be found / WiFi unstable	<p>The Battery WiFi turns off 5 hours after the start of the Battery. To reactivate the WiFi, press the LED button about 1 second or restart the system. To reset the WiFi, press the LED button three times 1 second within 6 seconds.</p> <p>If problem remains:</p> <ul style="list-style-type: none">- remove the lan cable during the configuration. Once the Battery has been configured correctly you can connect it again to the Internet.- check whether other mobile devices are connected the same wifi- try another mobile device
20	BMS Version not updated	<p>The App will only update the BMU. The BMU will update the BMS, Once the BMU is updated and the inverter communication is established correctly or right after the configuration is done, the BMS update can take about 20 Minutes</p> <p>If the BMS Version is not updated after 20min with stable inverter communication, follow the below Process:</p> <ol style="list-style-type: none">1. Update Firmware through the App again2. Restart the system<ol style="list-style-type: none">a. Switch off the Inverter first, then switch off the battery second (Press LED for 5 seconds)b. Wait for 30 Secondsc. Turn on the Battery first, then turn on the inverter second3. Wait for 20 Minutes4. Check BMS Firmware Version again with App. If Version is still wrong, do the update process again (if possible with another mobile device).

2.4 Battery <-> inverter communication / no charging or discharging

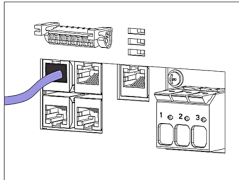
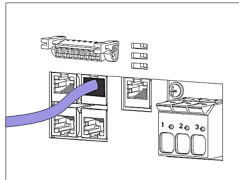
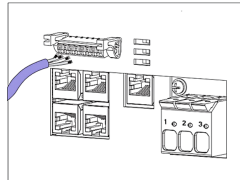
No.	Name	Description
21	Configuration	<p>Check if the configuration is correct. Refer to latest "BYD Battery-Box Premium HVS & HVM Compatible Inverter List" (V2.2 or above) available at: www.bydbatterybox.com</p> <p>Make sure the inverter is configured correctly.</p>
22	App Configuration and Firmware	<p>Please check if the App configuration was successful and the Firmware is the most recent one. If there are problems, please refer to Section 2.3</p>
23	Check DIP Switch	<p>If only one tower, or two towers parallel connected, all DIP switches should be in position: LEFT (except for Kostal PIKO MP plus - refer to manual)</p> <p>ON OFF</p> <p><input type="checkbox"/> CAN</p> <p><input type="checkbox"/> RS485</p> <p><input type="checkbox"/> COM</p> <p>If 3 towers HVS/HVM are in parallel connection, see manual for DIP configuration</p>
24	Communication connection	<p>Does the inverter properly detect the battery? Check if the inverter detects the battery parameters (e.g SOC, battery temperature) correctly. If not, check cabling:</p> <ul style="list-style-type: none"> - Confirm PIN / Cable Configuration for the specific inverter model - Replace the communication cable (min. CAT5! - better CAT7) - For Fronius & SMA: check the enable signal (necessary for battery activation) <p>Depending on the Inverter model, one or two of the three options of communication ports shown below can be used (refer to the manual!). Please try the other port and communication option if available for the inverter type.</p> <div style="display: flex; justify-content: space-around; align-items: flex-end;"> <div style="text-align: center;">  <p>Option a) CAN</p> </div> <div style="text-align: center;">  <p>Option b) RS485</p> </div> <div style="text-align: center;">  <p>Option c) CAN/RS485</p> </div> </div>
25	Grounding	<p>Connect Battery-Box directly to the ground-bus of the house (do not connect over inverter casing or other devices!). Only with a correct grounding of the battery, a trouble-free and secure data transmission can be guaranteed.</p>
26	Battery relay closed? / output voltage available?	<p>Once communication has been established between battery and inverter, the BCU is supposed to close the relay. Only then there will be output voltage. Therefore please check if output voltage is there. You can check either by Be Connect App / Be Connect plus tool or by checking if the inverter correctly shows battery voltage.</p>
27	Restart the system	<p>Defined restart (mind the sequence)</p> <ol style="list-style-type: none"> 1) Switch off Battery (press power button for 5 seconds)* 2) Turn off DC switch of the inverter 3) Turn off AC switch 4) Kostal only: Pull out the PV strings from inverter 5) wait 10 minutes 6) Turn on the battery (switch up) 7) Kostal only: Connect PV strings back to inverter 8) Turn on the AC switch 9) Turn on the DC switch on the inverter <p>*Note: if the battery does not switch off despite pressing the LED for 5 seconds, lift off the BCU to avoid further discharge and contact the service.</p>

2.5 SOC & charging logic

No	Name	Description
28	SOC at commissioning	New HVS / HVM modules have 30%SOC upon delivery. A new BCU might show a different SOC at the beginning (mostly 50% / 30% / 0%). However, this is only to be understood as a placeholder value, as a new BCU cannot measure the SOC of modules. As soon as the system starts to run (charge/discharge) the SOC detection is corrected gradually. The SOC calibration is completed at the latest after a full cycle.
29	SOC jumps	The SOC of an LFP battery cannot be measured. It is a calculated value. In general, the state of charge (SOC) of a battery is calculated using the voltage, but other factors such as temperature, current flow and charging behavior also play a role. The calculation of the state of charge is generally more precise if the battery regularly sees full cycles. Every now and then an SOC correction / calibration might occur. That is normal.

2.6 Unexpected shutdown

System has been successfully commissioned in the past and did run for some time. Later on an unexpected shutdown occurred.

No	Name	Description
30	Inverter Communication	The battery only works with an compatible external inverter. If for whatever reason the communication between battery and inverter is lost, the battery will shut down itself within 30minutes. Therefore, check which one did shut down first (battery or inverter) and check if inverter is properly detecting battery (e.g showing correct SOC or temperature). If communication problem remains, check according to section 2.4 .
31	Battery Logs / History Data	Sporadic alarms are hard to detect as they only occur sometimes. Therefore, it is very important to download and provide all the historic battery log files in order to identify the root cause. See section 2.8 for details.
32	Inverter Warning & Monitoring	Unexpected Shutdown can be caused by overall system settings. Therefore, it is necessary to evaluate inverter data as well. <ul style="list-style-type: none">- Which error message are shown in inverter (portal)?- Please provide access to Inverter portal (add info@eft-systems.de and tell us the name of the system in the portal)

2.7 Module Extension / Parallel connection

No	Name	Description
33	Extension	<p>Note: It is important that all modules of a storage tower have a similar state of charge (tolerance 5%). New modules have about 30%. Therefore, please only add the new module to the battery when the state of charge (SOC) is between 25% and 35% charge. Don't forget to adjust the number of modules in the configuration if it is necessary.</p> <p>If the 30% SOC rule has not been followed, temporary capacity loss and SOC jumps might occur. In this case a charger may be required to align the module SOC's. Contact your local service provider.</p>
34	Parallel connection	<p>Cabling / installation (including parallel connection) is described in the short installation guide. Some notes:</p> <ul style="list-style-type: none"> - DC bus bar needed to collect DC cables. There is a matching DC combiner box from BYD for the HVS / HVM. Details in the corresponding data sheet and manual of the BYD combiner box. - Towers need to be the same type (module type & quantity) - Communication established via master/slave. Only master unit needs to be configured and updated. No configuration of the slave BCUs necessary - Check DIP switches: If only one tower, or two towers parallel connected, all DIP switches should be in position: LEFT (except for Kostal PIKO MP plus - refer to manual). If 3 towers HVS/HVM are in parallel connection, see manual for DIP configuration

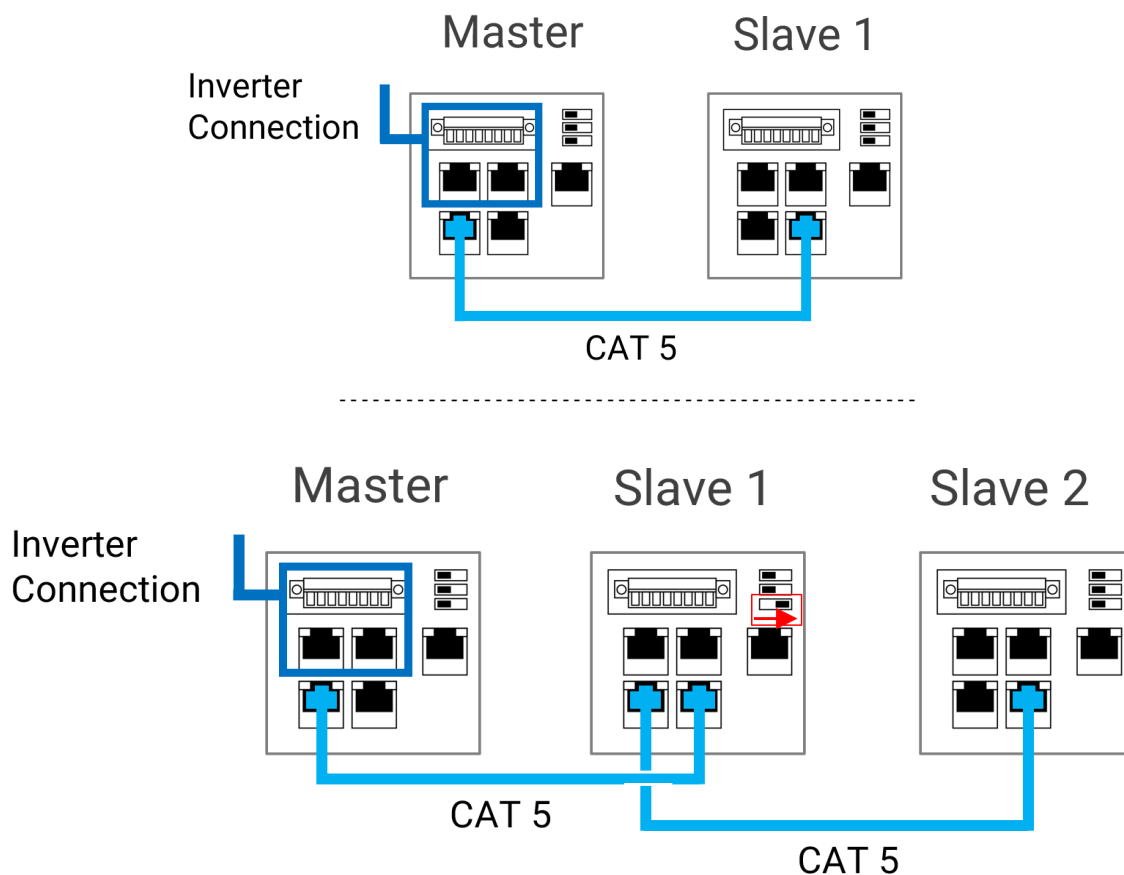

2.8 Be Connect Plus (BCP)

Be Connect Plus is a PC tool. With Be Connect Plus (BCP) you can:

- read the battery information,
- configure the battery system
- update BMU & BMS firmware
- Export / download battery logs

BCP is constantly being improved and updated. **Make sure to use the latest program version. You can download the latest version of the Tool on www.bydbatterybox.com / www.eft-systems.de / www.alppower.com.au.**

For the service analysis, please download and provide the data / logs as described in the program instructions (see PDF manual included).

Note: You need a computer with Windows that will be connected to the battery WiFi.
Login as Installer to Be Connect Plus, the password is the same as for the WiFi: BYDB-Box

Be Connect Plus_V1.6.1

disconnec Battery Type: HVM Inverter: Fronius HV Serial number: P030T020Z BATTERY BOX

System Info

Overview

Bat: 311.60V 20°C Refresh

System status: Normal

Inverter

DisCharging

Output: 0.00V

Current: 0.0A

Power: 0.00W

SOC: 30%

F/W Version

BMU: V3.16-B

BMS: V3.22-B

BMS Qty: 1

Module: 6

Cells Info

V-Max: 3.25V

V-Min: 3.24V

T-Max: 21°C

T-Min: 19°C

Others

Phase: Three

Grid: ON GRID

P-T: V9.1

Configuration

Inverter Type: Fronius HV Phase: Three

Battery Type: HVM Grid: On Grid

Modules in Seri: 6 Setup

2021-07-02 12:25:19 Copyright © 2020 BYD Company All rights reserved

2.9 LED event code (EC)

A constant white LED refers to the standby mode. White blinking LED means charge or discharge.

When the battery is initiating, the LED will flash white and blue with an interval time of 0.5 seconds (normal during startup). When the LED flashes blue with an interval time of 1 second it indicates an event code. Please start to count when the white LED begins to flash, then count how many times white and blue LED flashes. (also refer to the manual!)

Examples:

1xwhite, 3xblue → EC 103

1xwhite, 11xblue → EC 111

3xwhite, 3xblue → EC 303

Most Errors are caused by faulty communication, incorrect app configuration or missing restart after the app or BCP configuration. Please go in detail through: **Section 2.3 & 2.4**

Note: if the battery is not correctly configured with the app, the event code (EC) might be misleading.

Event Code (EC)	Measure
EC 102	<p>Abnormal shutdown (open panel) / PreCharge failure / DC reverse connection.</p> <ul style="list-style-type: none">- Check the DC-cable connection to the battery, inverter and combiner box (if there is any).- Make sure the cover for the connection area on the BCU is properly closed. <p>Important: If the panel is open, the battery won't turn on (for safety reasons)</p> <ul style="list-style-type: none">- Try to properly shut down the BCU (press for 5 seconds the LED power button) <p>If LED goes off: check installation and restart (battery first, then inverter second).</p> <p>If LED remains on (solid blue or 2xblue blinking): Remove the BCU from the tower to avoid a deep discharge. Measure the voltage of the system (see section 2.10) and contact your service partner.</p> <p>If problem remains:</p> <ul style="list-style-type: none">- Test another BCU, if available.
EC 103	<p>Voltage Sensor Failure / BMU<>BMS communication failure.</p> <ul style="list-style-type: none">- make sure all dip switches are in the correct position. For most configurations all on the left side (exception e.g. parallel connection of 3 towers and/or Kostal Piko MP). Refer to Manual!- Remove the topmost module and check whether the event code disappears. Note: A module with communication problems often works without restrictions at the lowest module position, since no communication with the base is necessary. <p>If problem remains:</p> <ul style="list-style-type: none">- Test another BCU, if available.
EC 104	<p>Faulty temperature sensor.</p> <ul style="list-style-type: none">- Check via BCP to identify the root cause module. Alternatively, follow "Module exclusion method" (see Section 2.11).
EC 105	<p>PackVoltage Sensor Failure.</p> <ul style="list-style-type: none">- Check DC-cable connection on battery, inverter and combiner box (if there is any).- Restart system properly (see step 7, section 1) <p>If problem remains:</p> <ul style="list-style-type: none">- Test another BCU, if available.

EC 203 Incorrect module quantity / Module not detected.
EC 303
EC 403
EC 503
EC 603
EC 703
EC 803

- Make sure app-configuration has been completed correctly (especially module type and quantity!).
- EC 203 to EC 803 means that a module is not recognized. The first number (= number of white flashes) indicates which module is probably affected. This module, or the module above it, can be responsible for the event code.

Example: EC 203 = second module from the top / EC 403 = fourth-top module.

- Remove the affected module and check whether the event code disappears. If not, check the module above.
- Rearrange the modules in the tower.

Note: A module with communication problems often works without restrictions at the lowest module position, since no communication with the base is necessary.

EC 106 Current Sensor Failure.

- Make sure that the latest firmware is installed and that the battery has been properly restarted.

If the problem remains:

- Test another BCU if available.

EC 107 Undervoltage.

- Shut down the system quickly to avoid further discharge. Check whether the system can shut down normally (by pressing the LED button for 5s).
- If the system cannot shut down normally, lift the BCU
- Follow **section 2.10** (Voltage measurement and undervoltage instruction)

EC 108 PreCharge Fault.

- Check DC-cable connection on battery, inverter and combiner box (if there is any).
- Restart system according to manual. (note: to properly shut down you need to press the LED button for 5 seconds. Make sure to start the battery before starting the inverter!)

If problem remains:

- Test another BCU, if available.

EC 109 Make sure that the latest firmware is installed and that the battery has been properly restarted. If the problem remains: it is Probably caused by a module. Follow the "Module exclusion method" (see **Section 2.11**).

EC 110 Low voltage.

The system needs to charge very soon and should not be further discharged!

1. Shut down the system quickly to avoid further discharge. Check whether the system can shut down normally (by pressing the LED button for 5s).
 - If the system cannot shut down normally, lift the BCU
 - Follow **section 2.10** (Voltage measurement and undervoltage)
2. Avoid further discharge of the battery, by searching the problem while the battery is completely off / BCU is lifted.
 - Check the other steps in the service guideline and also check the inverter (latest FW / correct/defined restart?) and with the inverter service, why the force charge doesn't work (e.g. any fault at the inverter). Do not turn on the battery before making sure the inverter should be able to charge the battery.
3. If everything has been checked and the system cannot be charged, make sure to avoid further discharge (e.g. remove BCU) and contact the service.

EC 111 Normal when the battery has just started.

LED will turn to solid white when:

- inverter communication works (-> Check inverter communication, **Section 2.4**)
- right after saving / redoing the configuration (Be Connect: go through whole wizard // Be Connect Plus: resave the configuration by using the "Setup" button and restart tool to refresh)

Please also make sure all dip switches are in the correct position. For most configurations all on the left side (exception e.g. parallel connection of 3 towers and/or Kostal Piko MP). Refer to Manual!

If EC111 remains even after the inverter detects battery and even after redoing app configuration: Remove the topmost module and check whether the event code disappears. If not, test another BCU if available.

EC 112 No communication with inverter.

Check inverter communication (**Section 2.4**)

2.10 Voltage measurement and undervoltage

ATTENTION: High voltage!

You can see the max. and min. cell voltage in the BeConnect App. You can also get the detailed module and cell voltage in the BCP Program (section 2.8) or measure it manually according to the below description:

Measurement of Tower Voltage

Take down the BCU and measure the tower voltage on the topmost module as shown below.

Note: The nominal voltage should be module quantity times 100V (for HVS) or module quantity times 50V (for HVM).

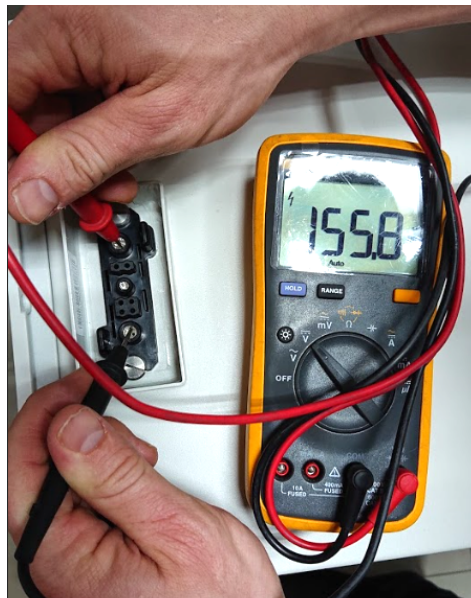

If the measured voltage deviates significantly from the nominal value, please check the electrical voltage at the individual modules, as shown in the following section.

Measurement of Individual Module Voltage

Positive



Negative



Measurement:



Undervoltage

A Module in which one of the 32 (HVS) / 16 (HVM) cells has a voltage of <1.5 V is in undervoltage (check with BCP [section 2.8] / BC if possible).

Modules HVS with >90 V and HVM with >45 V should be fine and you can continue to check other points according to this service guideline. Always **make sure the firmware is the latest!** If the module voltage is <90V (HVS) / <45V (HVM) but the single cell voltage is >1.5V, the battery needs to be charged quickly - follow the instructions of EC110 in **section 2.9**

- If only one module is in undervoltage: remove that one and try to start the system without it (if the remaining modules still comply with the Compatible Inverter List). Otherwise, make sure to avoid further discharge (e.g. remove BCU)

- If one, or all modules are in undervoltage: Contact the service as stated below and make sure to avoid any further discharge of the battery (e.g. remove BCU from the system)

When contacting the service, make sure to fill the service checklist completely and add the following information:

- Serial Numbers (of the BCU and all (affected) modules)
- Tower voltage and individual module voltages of all modules (related to Serialnumber)
- What was the status of the system switch on the BCU when the undervoltage (UV) happened? (tripped or not)
- If possible: Logs from the battery using BCP (**section 2.8**) and Screenshots showing the cell voltages
- Initial Firmware (FW) Version of the Battery when the UV happened (BMU and BMS)
- Inform if the BCU could shut down normally by pressing the LED button (note: if you have updated the FW after UV, write down here whether the battery could be switched off manually before the FW update.)
- Detailed description how and why the system reached Undervoltage if known. Information when the system was installed and commissioned and in which circumstance and when the undervoltage happened. If the battery was never running before: Why did it never work before, and what was the battery's status when the battery was left (on / off / LED).
- Inverter Model, Serial Number and inverter logs.
- Access to the inverter portal (add info@eft-systems.de and tell us the name of the system in the portal)

2.11 Identifying a faulty module / Module exclusion method

The module quantity must be adjusted in the app whenever the number of modules is changed!

1. Build the Battery-Box with the minimum available number of Modules (HVS: 2 modules, HVM: 3 modules).

2. **Check System. If Okay**, add one module at a time, adjust the module number in the app and check again.

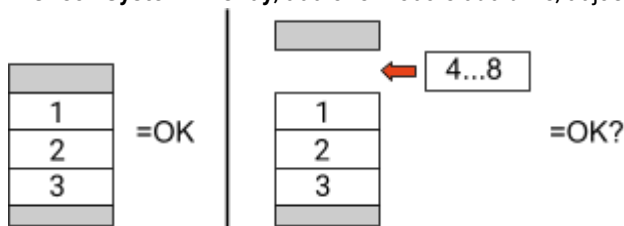

3. **If not okay**: The faulty module is probably one of the modules in the tower. Take one of the spare modules and exchange each of the remaining modules with the spare module one at a time. Check the battery status after each step. If battery status turns to "OK", the faulty module is the one that was exchanged.

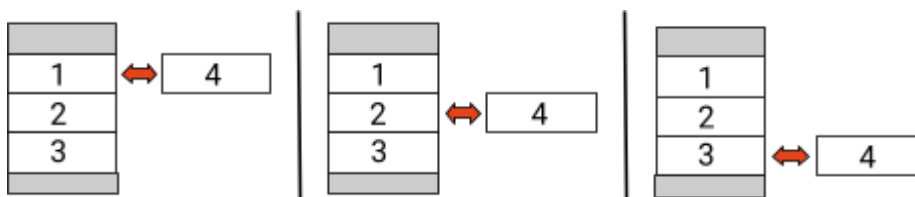

3. SERVICE TASKS

Please go through the general steps beforehand, see chapter 1.

3.1 BCU replacement

Have you detected a faulty BCU?:

After replacing the BCU, please do not forget to re-do the configuration and firmware-update with the app or BCP.

3.2 Module Replacement

Have you detected a faulty module?:

In the meantime you can use the battery system with the remaining modules and a correspondingly reduced capacity (take into account the minimum number of modules).

Please note: It is important that all modules of a battery tower have a similar state of charge (SOC) with a tolerance of 5%. New modules have about **30%** SOC. If the remaining modules have not yet been put into operation (not charged / discharged), the new module can easily be added. Otherwise, it is basically a module extension. In this case, please add the new module to the system only when the system has a SOC between 25% and 35% (see extension process in the manual). Make sure to configure correctly after any change in module number.

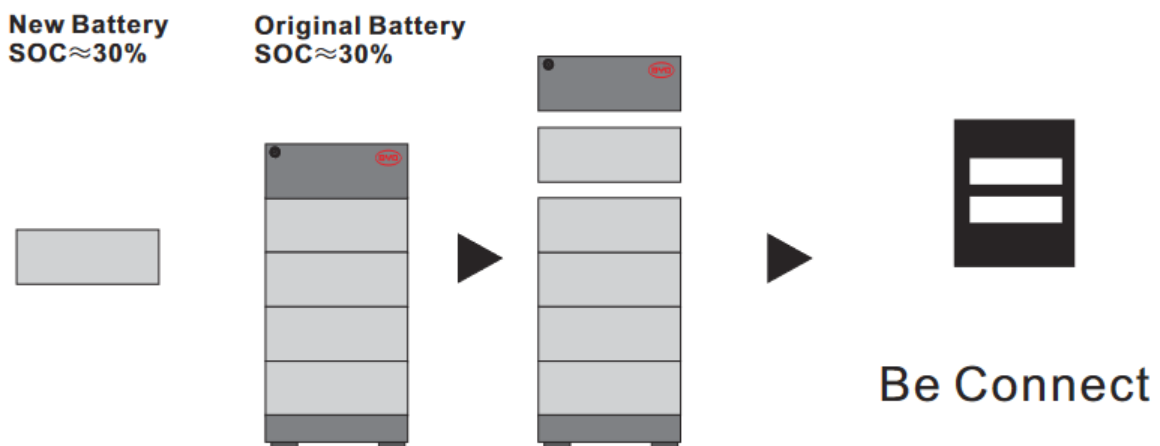

BYD Battery-Box Premium HVS/HVM Service Checklist - V1.5 EN

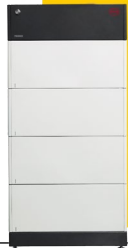

Important: The installation and all other kinds of works or measurements in combination with the BYD Battery-Box are only allowed by professional and qualified electricians. Improper handling can cause danger and damage. This document does not replace the official BYD manuals and documents. No responsibility is accepted for the accuracy of the information.

1. GENERAL STEPS

Please carefully check **all** „General Steps“ from page 3 of the Service Guideline and confirm this in the boxes below

- | | | |
|--------------------------|----------------------------|-----------------------|
| 1.1 Configuration | 1.4 Closed Connection Area | 1.7 Restart |
| 1.2 Only HVS or HVM | 1.5 Latest Firmware | 1.8 Correct Operation |
| 1.3 External Connections | 1.6 App Configuration | |

2. ERROR RELATED ANALYSIS

Please mark the **error related** Analysis from Chapter 2 of the Service Guideline that you checked, and collect all the information related to those Sections

- | | | |
|--|--|--|
| 2.1 BCU shows no reaction / No LED | 2.5 SOC & charging logic | 2.9 BCU LED event code (EC) |
| 2.2 BCU switch cannot be pulled up / LED remains on | 2.6 Unexpected shutdown | 2.10 Voltage measurement and undervoltage |
| 2.3 Problem with FW Update / App Configuration / Battery WIFI | 2.7 Module Extension / Parallel connection | 2.11 Identifying a faulty module / Module exclusion method |
| 2.4 Battery <> Inverter communication / no charging or discharging | 2.8 Be Connect Plus (BCP) | |

3. SERVICE INFORMATION

Please fill all available information in below table. Some information like the Serial Number of the BCU is mandatory to receive service.

• Service Ticket Number or System ID:

• Installer / Delivery Address / Contact:

Company	ZIP / City
Contact Person	Phone
Street / Nr.	Email

• System Information

Battery Configuration (e.g. HV55.1 / 2xHVM11.0 /...)	BMU Firmware
BCU Serial Number	BMS Firmware
BCU Connected to Internet	Yes No
Inverter Brand + Model	Inverter Firmware
Inverter Serial Number	System Name on Inverter Portal
Commissioning Date	(Provide access for: info@eft-systems.de)

• Service Information

BCU EventCode (EC)	Inverter Error Code
Was the battery charging / discharging before (was the system working normally before?)	Yes No
Take pictures of open communication port in the BCU and Inverter clearly showing connection cables	
Get Data of the Battery-Box with the Be Connect Plus (BCP) Programm (see chapter 2.8)	
Description of the Problem	

Please provide any additional information that is necessary or could help in the analysis of the service case (e.g. serial number of a wrong module, video of a special behaviour; pictures; app screenshots; module voltages...)

By contacting us you confirm, that a qualified person has done the necessary control and collected all available information above.

Service Contact:	Europe: EFT-Systems GmbH www.eft-systems.de service@eft-systems.de +49 9352 8523999 +34 9106 02267 (ES) +44 2037 695998 (UK) +39 0287 368364 (IT)	Australia: Alps Power Pty Ltd www.alpspower.com.au service@alpspower.com.au +61 02 8005 6688
------------------	---	---

For Europe only: Register Ticket directly in the Online Service Center: <https://support.eft-systems.de/>

